



Boise Cascade®  
MILLWORK



Boise Cascade®  
MILLWORK

# DALLAS MILLWORK



[millwork.bc.com](http://millwork.bc.com)  
3130 N. Longhorn Drive  
Suite 100  
Lancaster, Texas 75134  
1-833-757-0138

# STOCK CATALOG



**Boise Cascade®**  
MILLWORK

# WHY BOISE CASCADE MILLWORK?

Boise Cascade® Millwork is a division of Boise Cascade, one of the nation's largest manufacturers and distributors of building materials for the residential and commercial construction industry. For more than 60 years, Boise Cascade has served homebuilders, contractors, developers, and homeowners – and now we're bringing that expertise to millwork. With ten locations in some of the country's fastest growing markets, Boise Cascade Millwork offers top-of-the-line exterior and interior door solutions and components. If you can imagine it, we can get it or create it. At Boise Cascade Millwork we take pride in meeting the demands of our customers. Only Boise Cascade Millwork can leverage the buying power and reach of Boise Cascade Building Materials Distribution to get the best value and the toughest-to-access inventory. We understand that it's more than a just a door, it's a partnership you can count on with the brands your customers can rely on.



**Boise Cascade®**  
MILLWORK



## TABLE OF CONTENTS

## PAGE #

PrismaGuard® Prefinish	1
PrismaGuard® Premium Paint	2
Therma-Tru Doors	
Classic Craft Walnut	3
Classic Craft Mahogany Common Arch	4
Classic Craft®	5-11
Fiber-Classic® Oak	12
Fiber-Classic® Mahogany/Oak	13
Smooth-Star®	14-15
Steel-Profiles™/Traditions	16
Advanta Lite Frame	17
Glass	
Calix	17
Echelon	18
Latitude	18
Homeward™	19
Augustine®	19
Borrassa®	20
Lucerna®	20
Saratoga™	21
Texas Star	21
Riserva®	22
Pembrige™	22
Axis®	23
Internal Blinds	24
Reeded	25
Satin Etch	26
Chord	27
Granite	28
Clear	29
Grilles	30
Jambs	31
Fasteners Setting Tool & Screw Plug Covers	31
Cove Mould	32
Brickmould	32
Mullions	33
Composite Mull Casing	34
Sills	35-37
Door Bottoms	38-39
Astragals	39-40
Endrail	41
Weatherstrip	42
Hinges	42-43
Handlesets	44-45
Speakeasy's	45
Hardware	46-47
Door & Lite Divider Bars	47
Accessories	48
Simpson Doors	
Mahogany Exterior	49-50
Western Hemlock Exterior	51-52
Knotty Alder Exterior	53
Redi-Prime® Interior	54-55
Western Hemlock Interior	55-56
Knotty Alder Interior	57-58
Pine Interior	59
Knotty Pine Interior	60
Steve's	
Molded and Flush Interior Doors	61-64
Marwin	
Attic Stairs	65
Pocket Door Frames	66
GM Wood Products	
Jambs	67-68
Casings	69
Penrod Bard Door Hardware	70
Kwikset	70
Kitchen Kompact Cabinetry	71-72



Boise Cascade®  
MILLWORK

## PRISMAGUARD PREFINISH

Handcrafted and professionally applied in a controlled environment, low-maintenance PrismaGuard® finish preserves your door's lasting beauty and protects against normal wear and tear, saving you time and money. And it's backed by a 10-year limited finish warranty for your peace of mind.

### PrismaGuard® Stain Options

Stains are shown on Classic Craft Mahogany Grain



### PrismaGuard® Brushed Finish Options

Available for select Smooth-Star door styles

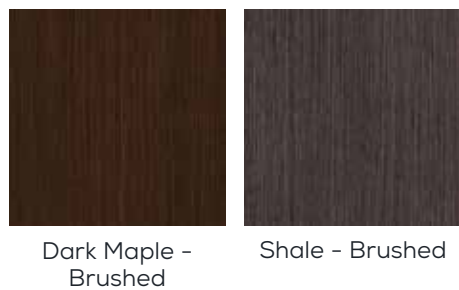

**10 YEAR**  
LIMITED  
WARRANTY  
TRANSFERABLE  
Classic Craft

**10 YEAR**  
LIMITED  
WARRANTY



Durable  
Topcoat



Professional  
Application

Note: Finish colors may vary from an actual application due to fluctuations in finishing or printing.



Boise Cascade®  
MILLWORK

millwork.bc.com  
3130 N. Longhorn Drive, Suite 100  
Lancaster, Texas 75134  
1-833-757-0138

## PRISMAGUARD PREMIUM PAINT

Add a pop of color and tailor the look of the entry. PrismaGuard premium paint is designed with high-definition color and optimal sheen to enhance the look of smooth and wood-grained Therma-Tru® products for a beautiful lasting impression.

### PrismaGuard® Paint Options



Boise Cascade®  
MILLWORK

**SYMPHONY**  
COLLECTION™

## Introducing the Symphony Collection by Boise Cascade

Enhance your home with this palette offering a ten year PrismaGuard warranty.



**10 YEAR**  
LIMITED  
WARRANTY  
TRANSFERABLE  
Classic Craft

**10 YEAR**  
LIMITED  
WARRANTY



Durable  
Topcoat



Professional  
Application

Note: Finish colors may vary from an actual application due to fluctuations in finishing or printing. See your Therma-Tru seller for details on the PrismaGuard limited warranty and exclusions. All trademarks are property of their respective owners.

**THERMA-TRU**  
DOORS



Boise Cascade®  
MILLWORK

## CLASSIC CRAFT WALNUT



## CLASSIC CRAFT MAHOGANY COMMON ARCH



Boise Cascade®  
MILLWORK

millwork.bc.com  
3130 N. Longhorn Drive, Suite 100  
Lancaster, Texas 75134  
1-833-757-0138

Stock status is subject to availability, please contact your  
Boise Cascade Millwork Representative with any questions.

SDLF1 = SIMULATED DIVIDED LITES  
SDLF3 = SIMULATED DIVIDED LITES  
SDLF6 = SIMULATED DIVIDED LITES

THERMA TRU®  
DOORS



Boise Cascade®  
MILLWORK

## CLASSIC CRAFT®

Designed to echo the grain of the largest species of American Hemlocks – the Western Hemlock tree – found in lush coastal rainforests of the Pacific Northwest.

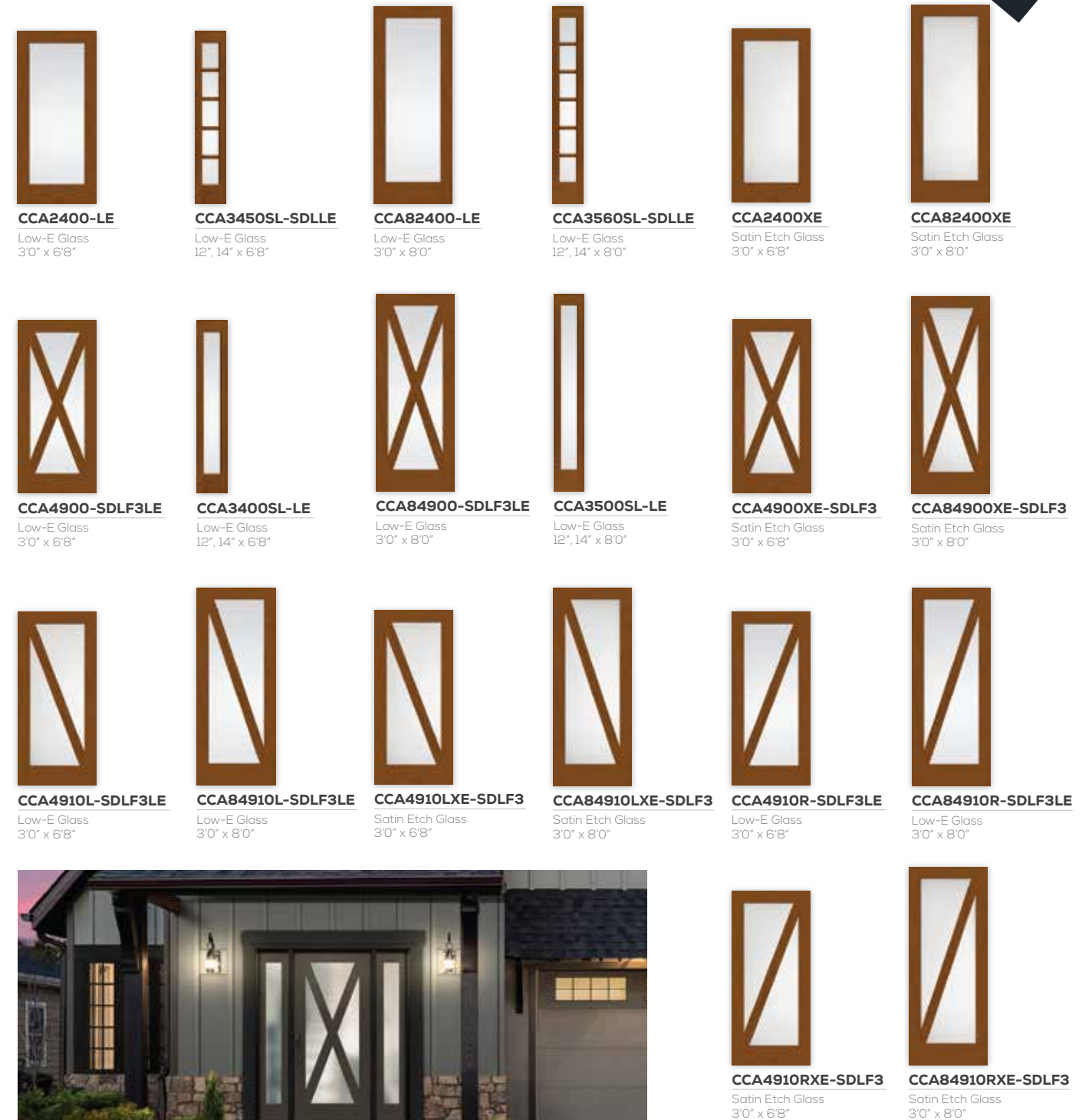
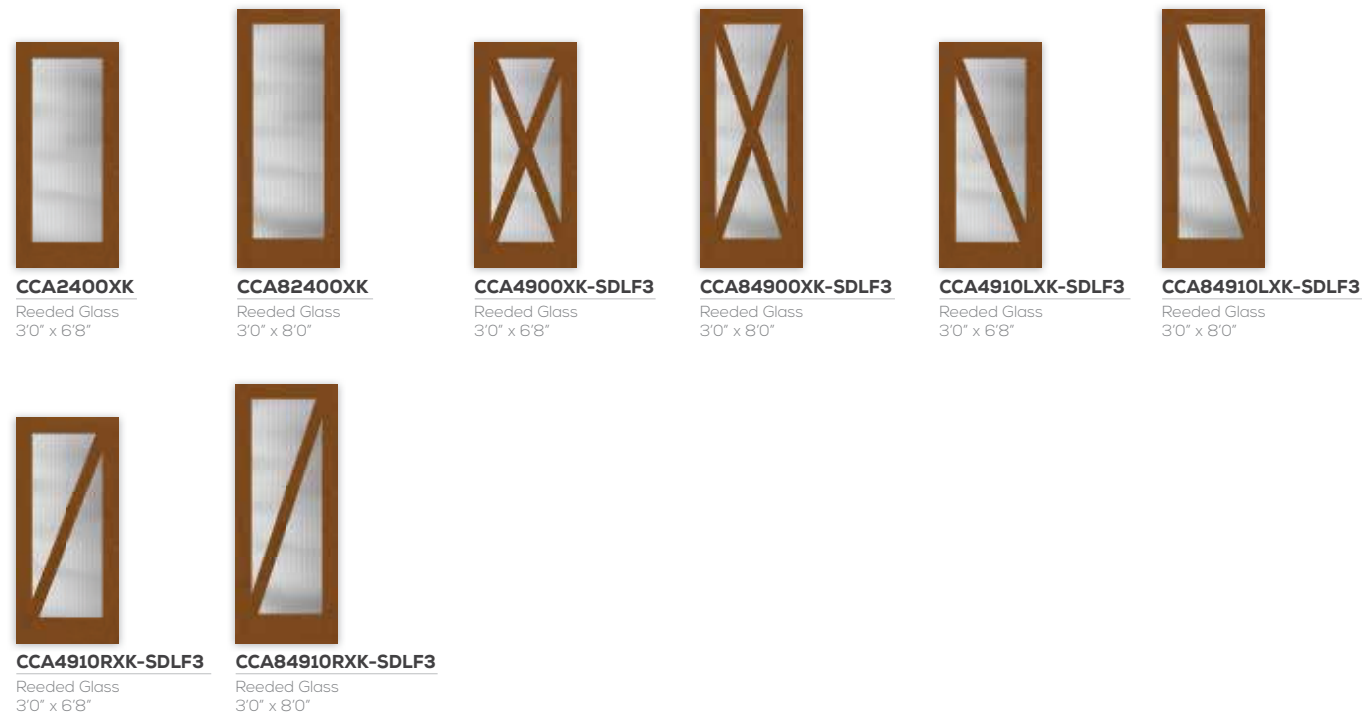

**THERMA TRU**  
DOORS

SDLF1 = SIMULATED DIVIDED LITES  
SDLF3 = SIMULATED DIVIDED LITES  
SDLF6 = SIMULATED DIVIDED LITES

SDL = SIMULATED DIVIDED LITES  
SDLF3 = SIMULATED DIVIDED LITES



Boise Cascade®  
MILLWORK

millwork.bc.com  
3130 N. Longhorn Drive, Suite 100  
Lancaster, Texas 75134  
1-833-757-0138



## CLASSIC CRAFT® (CONTINUED)

Classic Craft® doors offer the authentic look of wood. It's virtually impossible to tell the difference. Performing as exceptionally as they look, offering long-lasting energy efficiency, durability and security.



**CCA211-1D**  
Homeward Glass  
3'0" x 6'8"



**CCA211-1C**  
Homeward Glass  
3'0" x 6'8"



**CCA8211-1D**  
Homeward Glass  
3'0" x 8'0"



**CCA8211-1C**  
Homeward Glass  
3'0" x 8'0"



**CCA210-LE**  
Low-E Glass  
3'0" x 6'8"



**CCA8210-LE**  
Low-E Glass  
3'0" x 8'0"



**CCA210XC**  
Chord Glass  
3'0" x 6'8"



**CCA8230XN-SDL**  
Granite Glass  
3'0" x 8'0"



**CCA240-SDLLE**  
Low-E Glass  
3'0" x 6'8"



**CCA8240-SDLLE**  
Low-E Glass  
3'0" x 8'0"



**CCA240XC-SDL**  
Chord Glass  
3'0" x 6'8"



**CCA8240XC-SDL**  
Chord Glass  
3'0" x 8'0"



**CCA240XN-SDL**  
Granite Glass  
3'0" x 6'8"



**CCA8210XC**  
Chord Glass  
3'0" x 8'0"



**CCA210XN**  
Granite Glass  
3'0" x 6'8"



**CCA8210XN**  
Granite Glass  
3'0" x 8'0"



**CCA220-SDLLE**  
Low-E Glass  
3'0" x 6'8"



**CCA8220-SDLLE**  
Low-E Glass  
3'0" x 8'0"



**CCA220XC-SDL**  
Chord Glass  
3'0" x 6'8"



**CCA8220XC-SDL**  
Chord Glass  
3'0" x 8'0"



**CCA220XN-SDL**  
Granite Glass  
3'0" x 6'8"



**CCA8220XN-SDL**  
Granite Glass  
3'0" x 8'0"



**CCA230-SDLLE**  
Low-E Glass  
3'0" x 6'8"



**CCA8230-SDLLE**  
Low-E Glass  
3'0" x 8'0"



**CCA230XC-SDL**  
Chord Glass  
3'0" x 6'8"



**CCA8230XC-SDL**  
Chord Glass  
3'0" x 8'0"



**CCA230XN-SDL**  
Granite Glass  
3'0" x 6'8"





Boise Cascade  
MILLWORK

# CLASSIC CRAFT® (CONTINUED)



**CCA8240XN-SDL**  
Granite Glass  
3'0" x 8'0"



**CCA260-SDLLE**  
Low-E Glass  
3'0" x 6'8"



**CCA8260-SDLLE**  
Low-E Glass  
3'0" x 8'0"



**CCA260XC-SDL**  
Chord Glass  
3'0" x 6'8"



**CCA8260XC-SDL**  
Chord Glass  
3'0" x 8'0"



**CCA260XN-SDL**  
Granite Glass  
3'0" x 6'8"



**CCA8260XN-SDL**  
Granite Glass  
3'0" x 8'0"



**CCA87100-LE**  
Low-E Glass  
3'6" x 8'0"



**CCA87200-SDLLE**  
Low-E Glass  
3'6" x 8'0"



**CCA87300-SDLLE**  
Low-E Glass  
3'6" x 8'0"



**CCA87400-SDLLE**  
Low-E Glass  
3'6" x 8'0"



**CCA87600-SDLLE**  
Low-E Glass  
3'6" x 8'0"



**CCA1100**  
3'0" x 6'8"



**CCA81100**  
3'0" x 8'0"



**CCA4905-DDBF3**  
3'0" x 6'8"



**CCA84905-DDBF3**  
3'0" x 8'0"



**CCA4915L-DDBF3**  
3'0" x 6'8"



**CCA84915L-DDBF3**  
3'0" x 8'0"



**CCA4915R-DDBF3**  
3'0" x 6'8"

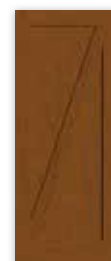

**CCA84915R-DDBF3**  
3'0" x 8'0"



1D = BLACK NICKEL CAMING  
1C = BRUSHED NICKEL CAMING  
SDL = SIMULATED DIVIDED LITES  
SDLF3 = SIMULATED DIVIDED LITES  
DDBF3 = DOOR DIVIDER BARS



Boise Cascade  
MILLWORK

millwork.bc.com  
3130 N. Longhorn Drive, Suite 100  
Lancaster, Texas 75134  
1-833-757-0138

THERMA TRU  
DOORS



## CLASSIC CRAFT® (CONTINUED)

Choose from our many door selections to complement the architectural style of the home. Choose from premium fiberglass entryways in four wood grains or a smooth paintable surface that all rival custom wood.



## FIBER-CLASSIC® OAK

Create an airy, open feeling in the home with larger daylight openings. EnLiten flush-glazed designs provide a simple profile with no added embellishments around the glass.







Boise Cascade<sup>®</sup>  
MILLWORK

## FIBER-CLASSIC<sup>®</sup> MAHOGANY / OAK

Fiber-Classic Mahogany complements rich wood tones in home exteriors, extending the look to the outside with beauty and elegance. Fiber-Classic Oak features the warm look and feel of natural Oak graining.

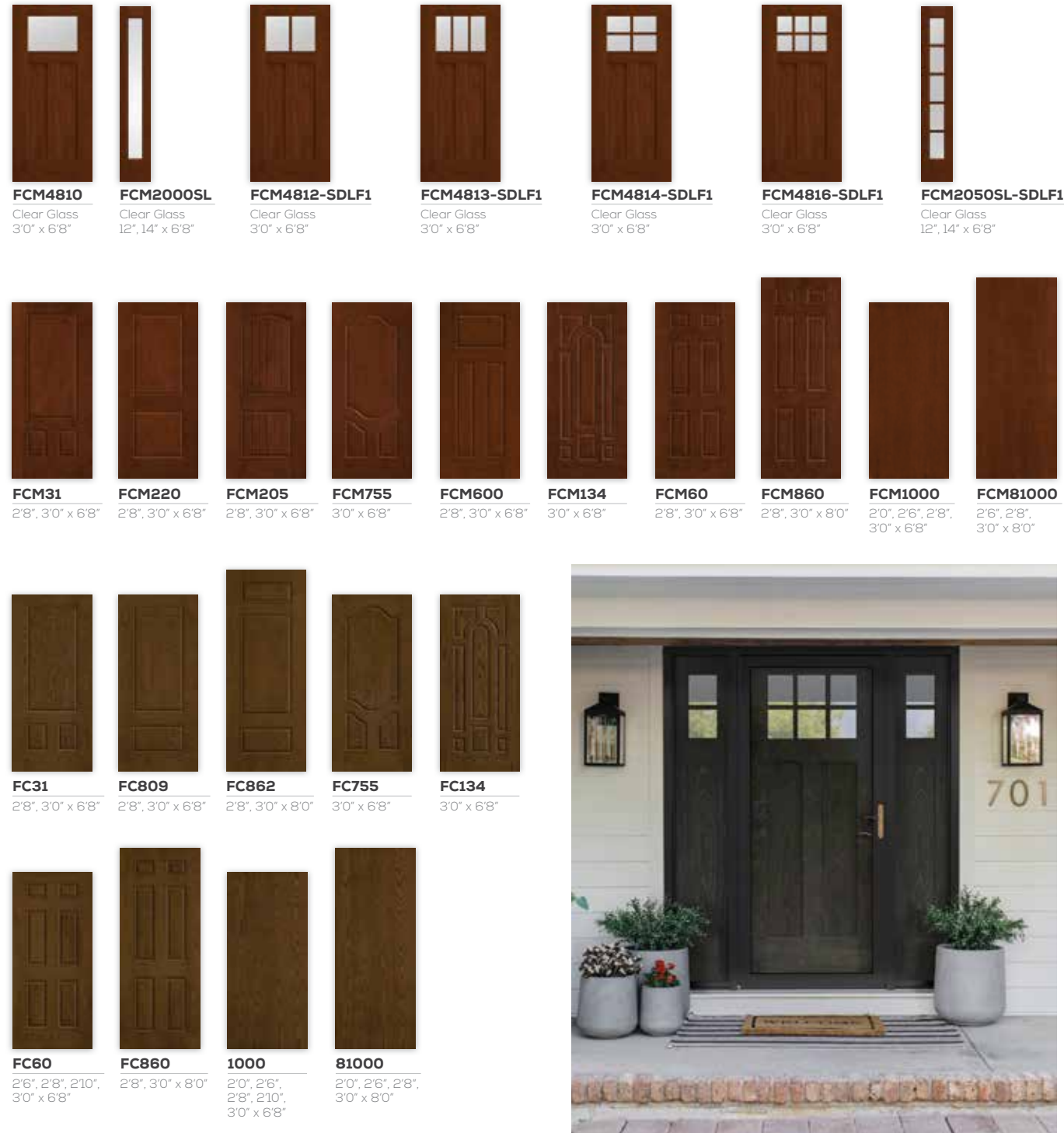

## SMOOTH-STAR<sup>®</sup>

Smooth-Star fiberglass doors are ready-to-paint with crisp, clean contours making them the more attractive and durable alternative to steel.

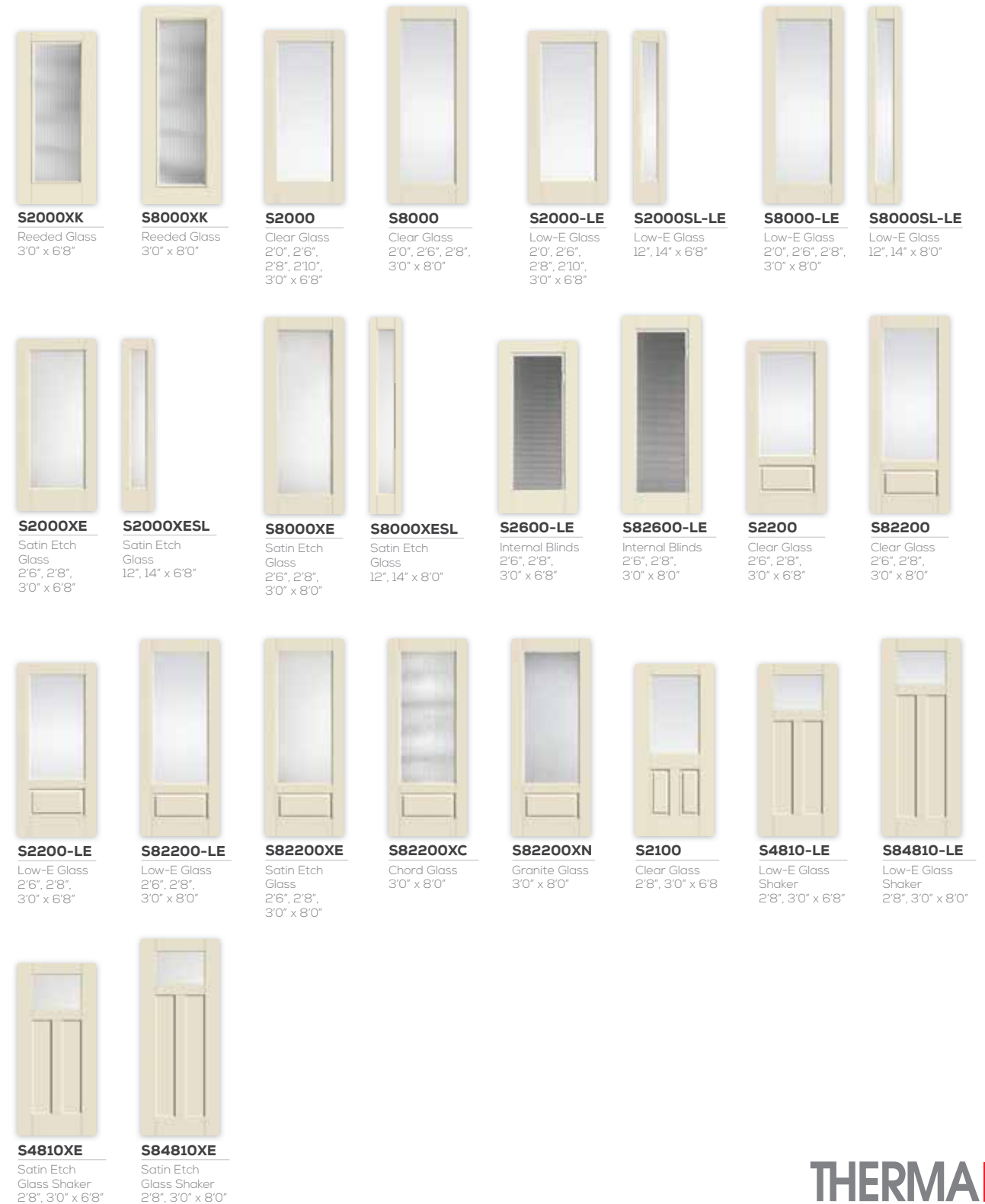

millwork.bc.com  
3130 N. Longhorn Drive, Suite 100  
Lancaster, Texas 75134  
1-833-757-0138

Stock status is subject to availability, please contact your  
Boise Cascade Millwork Representative with any questions.





Boise Cascade  
MILLWORK

## SMOOTH-STAR®

Smooth-Star fiberglass doors are ready-to-paint with crisp, clean contours making them the more attractive and durable alternative to steel.

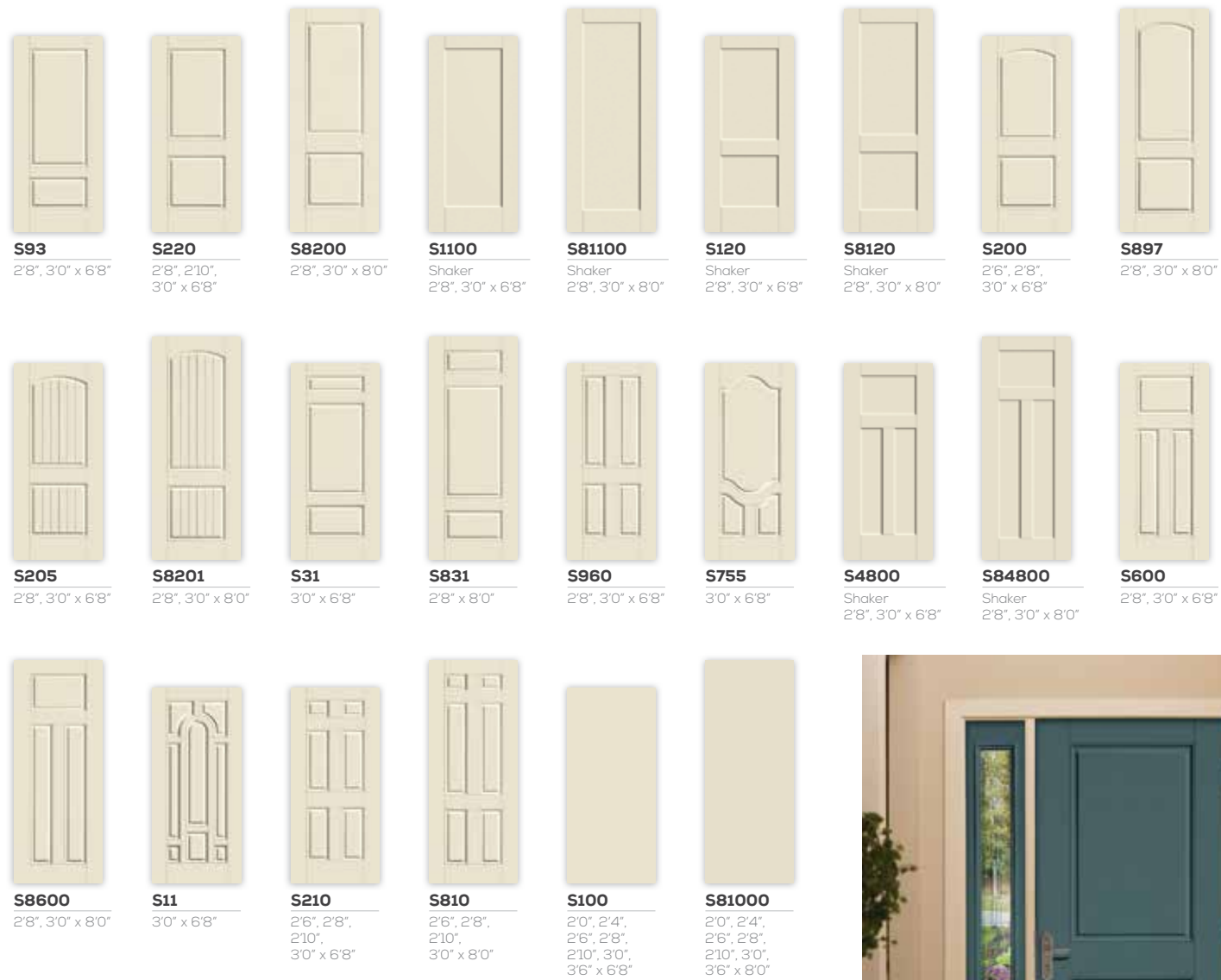

## STEEL - PROFILES™ / TRADITIONS

Coupling distinctive styling with affordability, Therma-Tru steel doors offer versatile front entry and house-to-garage options.



Boise Cascade  
MILLWORK

millwork.bc.com  
3130 N. Longhorn Drive, Suite 100  
Lancaster, Texas 75134  
1-833-757-0138

THERMA TRU  
DOORS



## ADVANTA LITE FRAME

A new frame of mind. Achieve a seamless look with the Advanta™ lite frame, an innovative, patented solution from Therma-Tru. Avoid the unsightly look of missing screw plugs and enhance the beauty of your home's entryway.

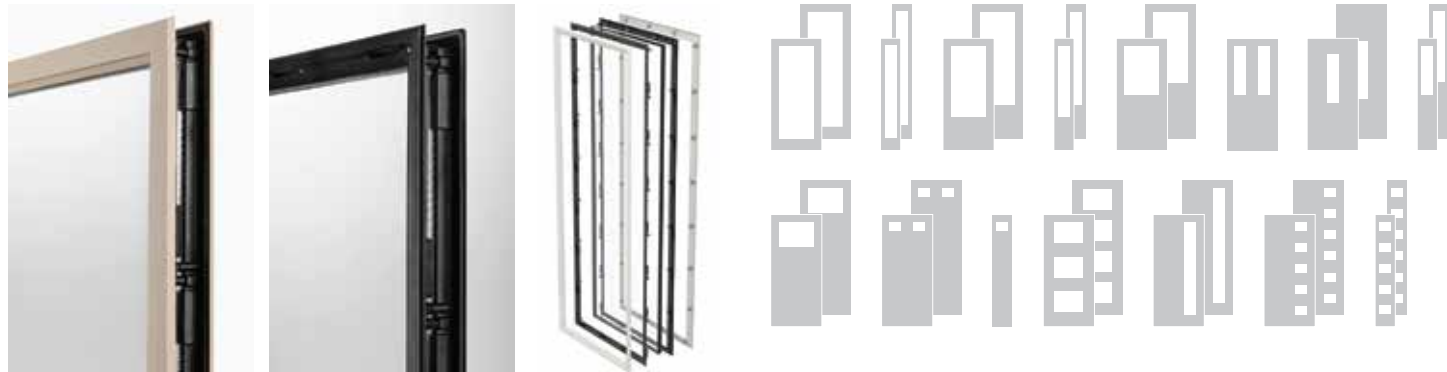

## CALIX

Glass Privacy Rating 1 10

Calix includes an on-trend "x" design and a delicate diamond pattern with 1 clear glass, providing fine-lined geometric appeal.

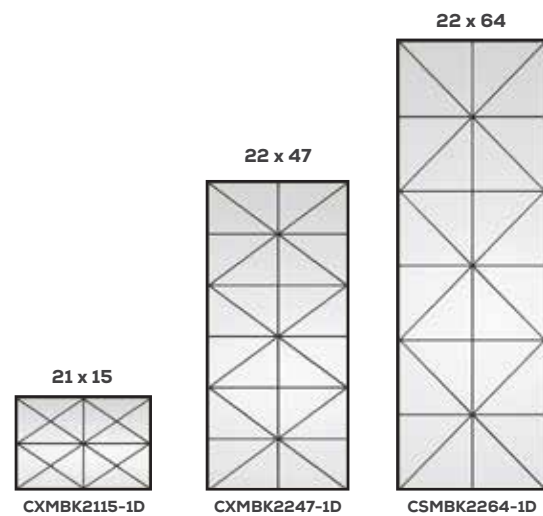

## ECHELON

Glass Privacy Rating 1 10

Echelon provides 1 clear glass accented with eased angles and clean edges infused with elements of diamonds and triangles.

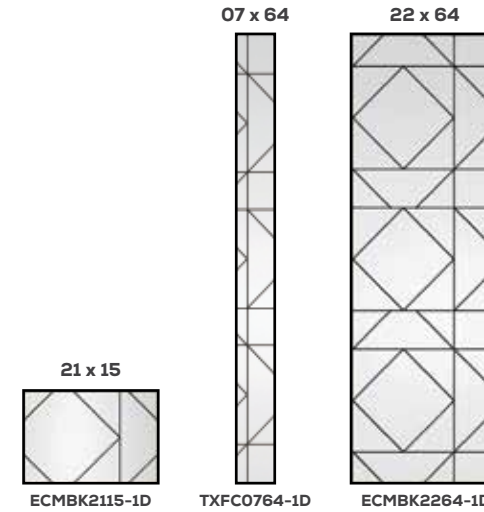

## LATITUDE

Glass Privacy Rating 1 2 10

Bending tradition. Latitude showcases 1 seeded glass and simple curved details in a half-moon geometric design.

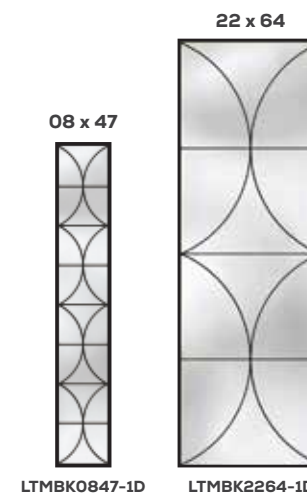



Boise Cascade  
MILLWORK

## HOMEWARD™

Glass Privacy Rating 1 **4** 10

The balanced Mission-style pattern of Homeward invites light to cascade through its distinctive clear bevels, seeded glass and gray artique glass. An ideal complement for a Transitional home design.

25 x 51

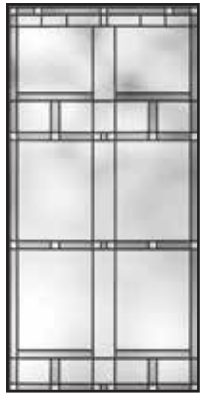

HWCCR2551-1D  
HWCCR2551-1C

25 x 42



HWCCR2542-1D  
HWCCR2542-1C



Caming Options



Black Nickel (1D)



Brushed Nickel (1C)

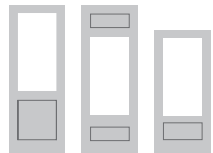

## AUGUSTINE®

Glass Privacy Rating 1 **7** 10

Augustine's swirl leaf design adds a touch of elegance. Made of round wrought iron and granite glass for ultimate privacy, Augustine pays homage to classic English styling.

25 x 51



AGCCW2551-NC-1W

25 x 51 Arched



AG2551A-1W

25 x 42



AGCCW2542-NC-1W

25 x 42 Arched



AG2542A-1W

Caming Options



Wrought Iron

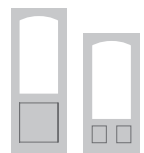
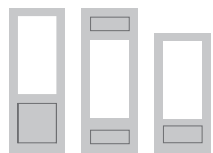

## BORRASSA®

Glass Privacy Rating 1 **10**

A statement of strength and beauty, Borrassa combines linear and curved wrought iron with hammered glass for ultimate privacy. Wrought iron decorative accents add an authentic Old World feel to this stately design.

Caming Options



Wrought Iron

25 x 51

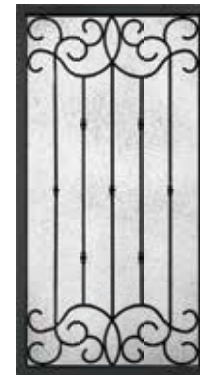

BACCW2551-KC-1W

25 x 51 Arched

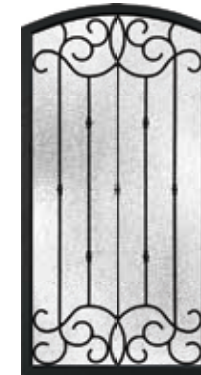

BACCW2551A-KC-1W

25 x 42



BACCW2542-KC-1W

25 x 42 Arched



BACCW2542A-KC-1W

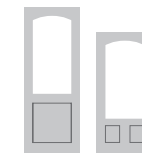
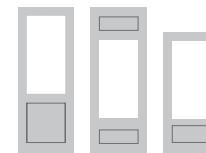

## LUCERNA®

Glass Privacy Rating 1 **7** 10

Named for the beauty of light it reflects, Lucerna glass presents an elegant, updated fleur-de-lis pattern in a spectrum of curved, diamond and rectangular bevels surrounded by smooth, swirling barn wood and heavily textured diamond border glass.

Caming Options



Black Nickel (1D)



Brushed Nickel (1C)

25 x 51

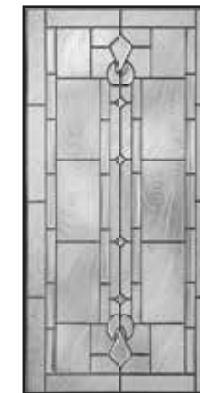

LCCCR2551-1C  
LCCCR2551-1D

25 x 42

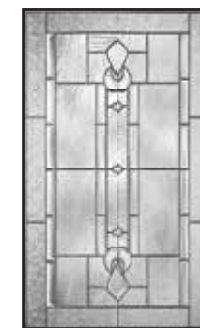

LCCCR2542-1C  
LCCCR2542-1D

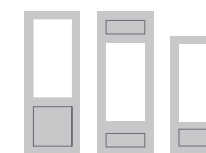

PRODUCT IMAGES SHOW EXTERIOR SIDE OF DOOR.

thermatru.com | 1-800-THERMA-TRU | 20



Boise Cascade  
MILLWORK

millwork.bc.com

3130 N. Longhorn Drive, Suite 100  
Lancaster, Texas 75134  
1-833-757-0138

THERMA TRU  
DOORS



Boise Cascade  
MILLWORK

## SARATOGA™

Glass Privacy Rating 1 **7** 10

Saratoga evokes a certain urban sophistication while offering modest privacy with its clear bevels, diamond glass, reed glass and coming. The geometric pattern bridges both modern and traditional designs.

### Coming Options

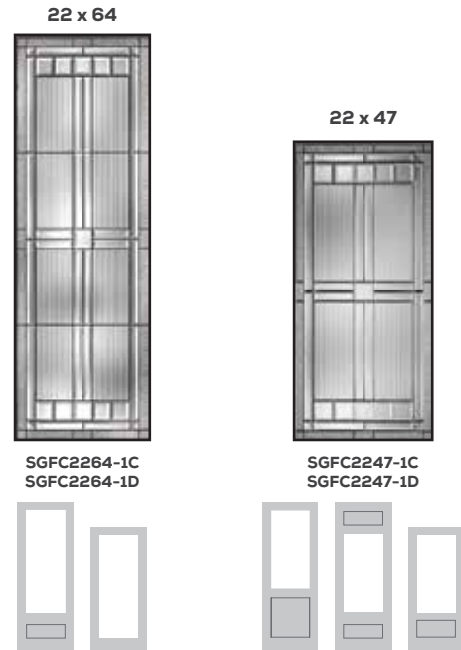

## RISERVA®

Glass Privacy Rating 1 **10**

Riserva combines oceanic glass with linear and curved wrought iron elements to create a simple yet elegant design. A perfect way to let natural light in while achieving ultimate privacy.

### Coming Options

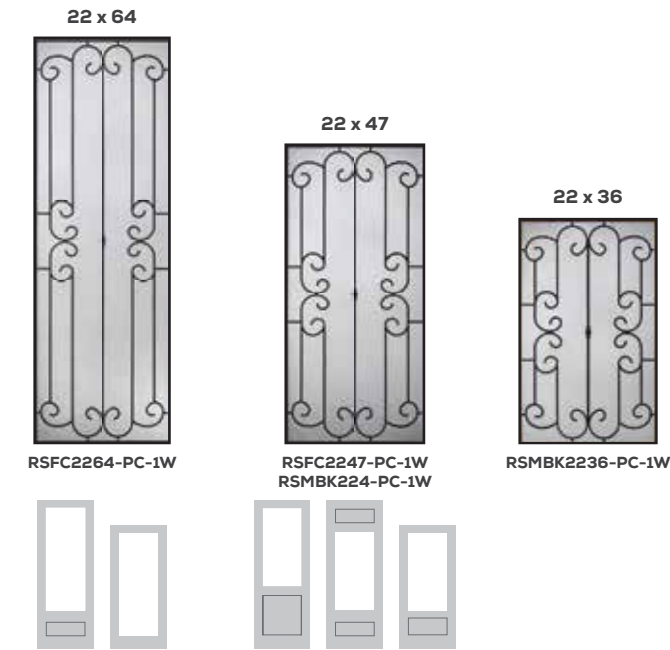

## TEXAS STAR

Glass Privacy Rating 1 **5** 10

Beautifully crafted with clear bevels, curved bevels, clear waterglass, granite glass, glue chip glass, there's no mistaking the inspiration for this recognizable design. Strong, independent and all-American.

### Coming Options

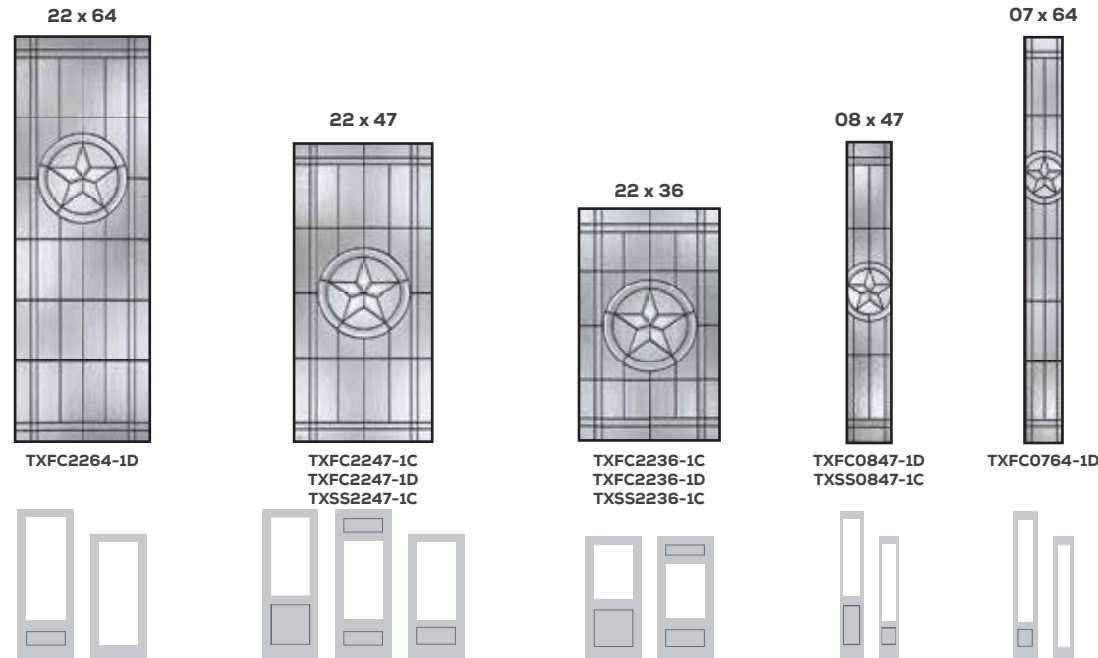
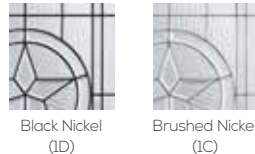

## PEMBRIDGE™

Glass Privacy Rating 1 **7** 10

Simplistic in its design, Pembridge features a field of hammered glass framed by gray baroque glass and multifaceted bevels. A central diamond shape adds a decorative touch.

### Coming Options

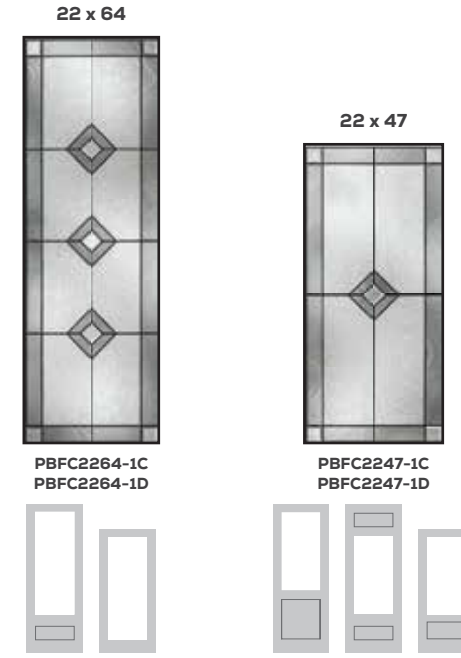
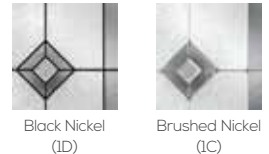

FC = BUFF  
SS = SMOOTH

PRODUCT IMAGES SHOW EXTERIOR SIDE OF DOOR.



Boise Cascade  
MILLWORK

millwork.bc.com  
3130 N. Longhorn Drive, Suite 100  
Lancaster, Texas 75134  
1-833-757-0138

Stock status is subject to availability, please contact your Boise Cascade Millwork Representative with any questions.

THERMA TRU  
DOORS

thermatru.com | 1-800-THERMA-TRU | 22



Boise Cascade  
MILLWORK

## AXIS®

Glass Privacy Rating 1 7 10

Simple and smart, Axis combines narrow reed glass in horizontal and vertical arrangements to create stunning contrast and modest privacy. A vertical band of clear glass bevels completes this linear design, ideal for Modern home styles.

Caming Options



Black Nickel  
(ID)

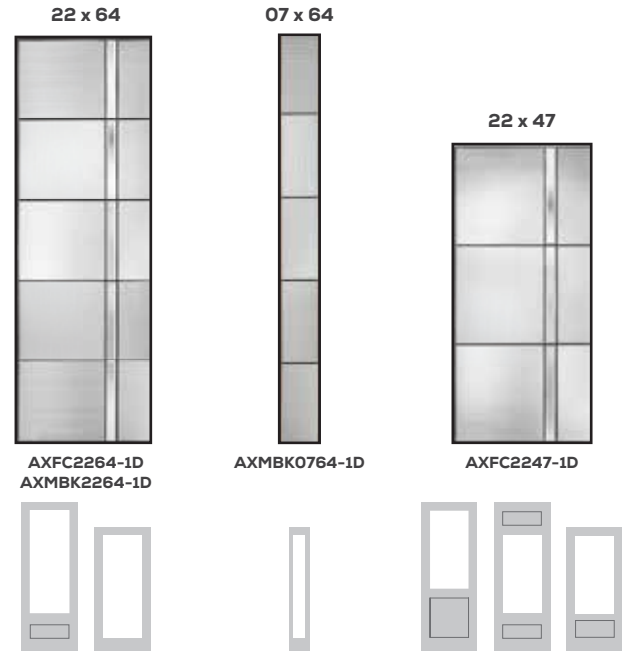

## INTERNAL BLINDS

Internal blinds provide the privacy and convenience of a cordless blind enclosed between glass. Control the desired level of light and privacy with a single handle that opens, closes and tilts the blinds.

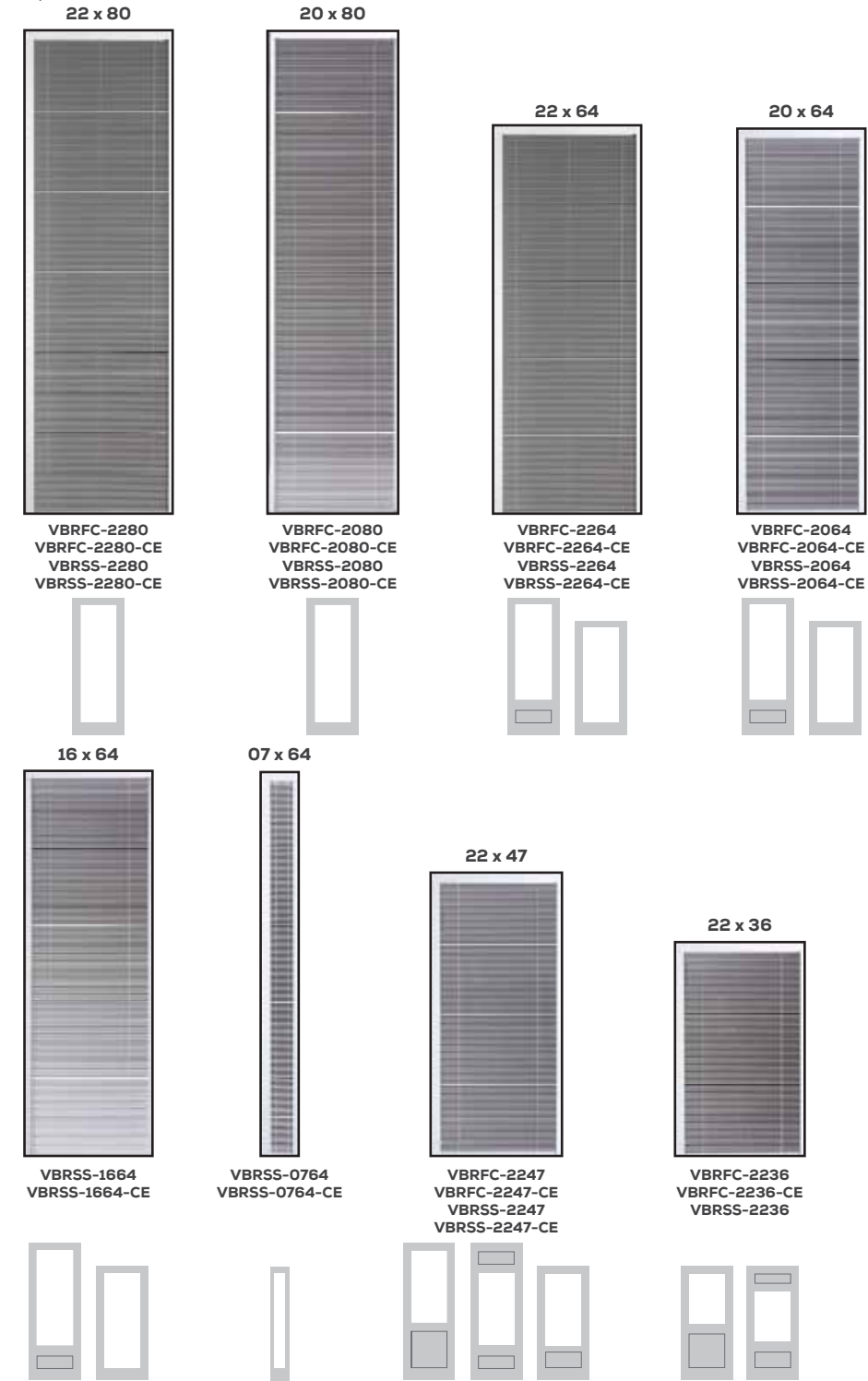

CE = LOW-E  
FC = BUFF  
SS = SMOOTH

PRODUCT IMAGES SHOW EXTERIOR SIDE OF DOOR.

THERMA TRU  
DOORS

thermatru.com | 1-800-THERMA-TRU | 24



Boise Cascade  
MILLWORK

millwork.bc.com  
3130 N. Longhorn Drive, Suite 100  
Lancaster, Texas 75134  
1-833-757-0138



Boise Cascade®  
MILLWORK

## REEDED

Glass Privacy Rating 1 7 10

Refined, transitional style. The clean lines of Reeded glass bring a modern look to the home, featuring a vertical, linear texture. Reeded glass provides ample natural light while maintaining moderate privacy.

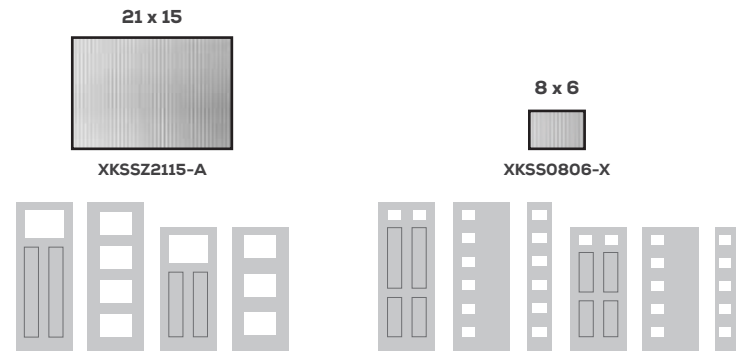

## SATIN ETCH

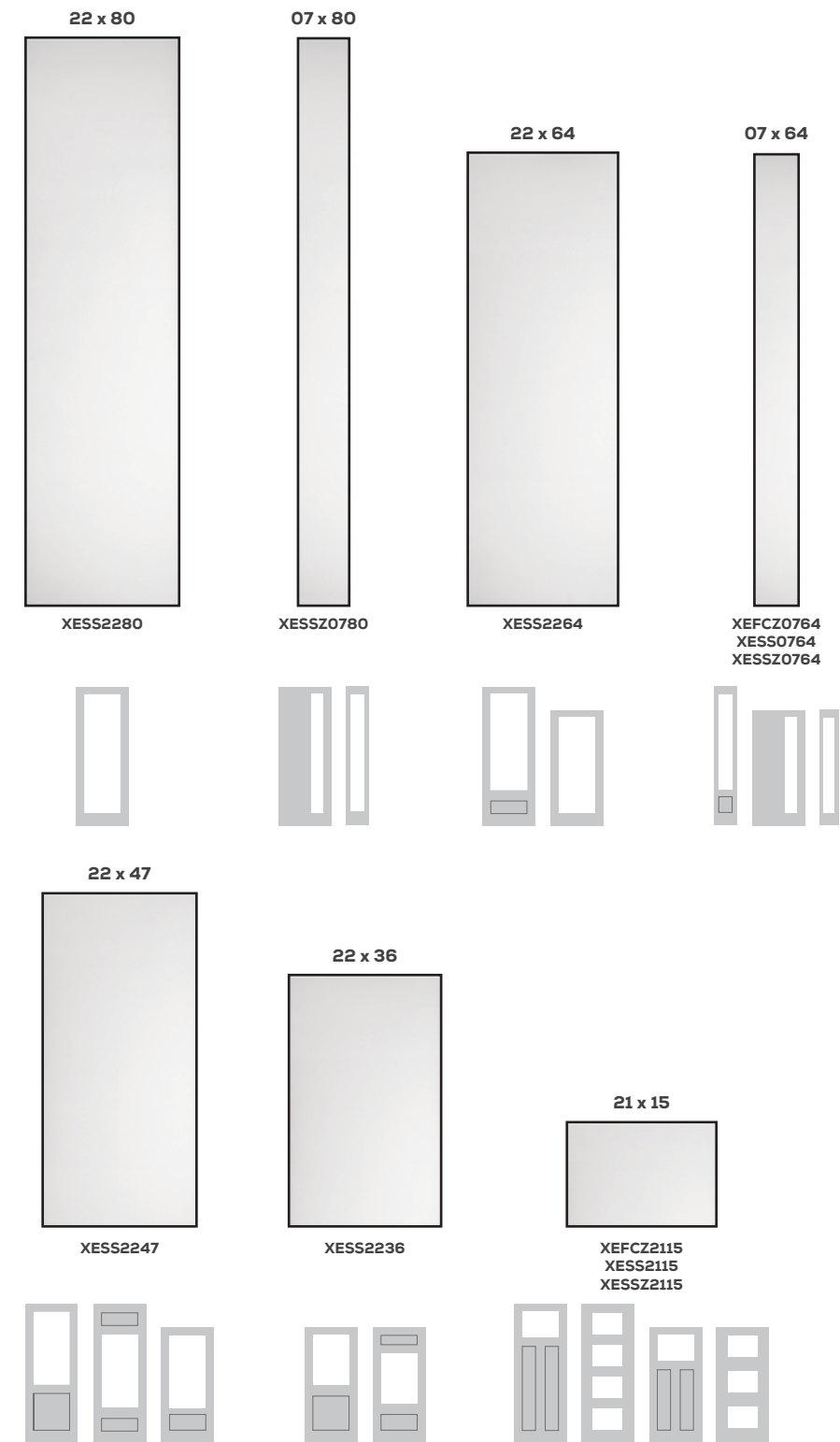

FC = BUFF  
SS = SMOOTH  
Z = FLAT FRAME

PRODUCT IMAGES SHOW EXTERIOR SIDE OF DOOR.

Stock status is subject to availability, please contact your Boise Cascade Millwork Representative with any questions.



Boise Cascade®  
MILLWORK

millwork.bc.com  
3130 N. Longhorn Drive, Suite 100  
Lancaster, Texas 75134  
1-833-757-0138

THERMA TRU®  
DOORS

thermatru.com | 1-800-THERMA-TRU | 26



# CHORD

Glass Privacy Rating 1 10

A vertical flowing pattern reminiscent of waves on the water.

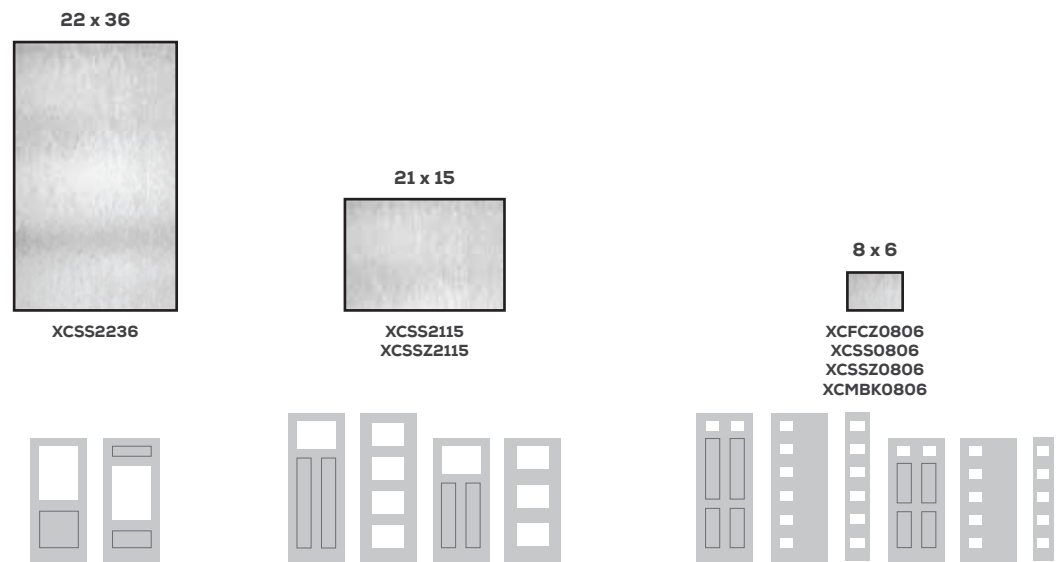
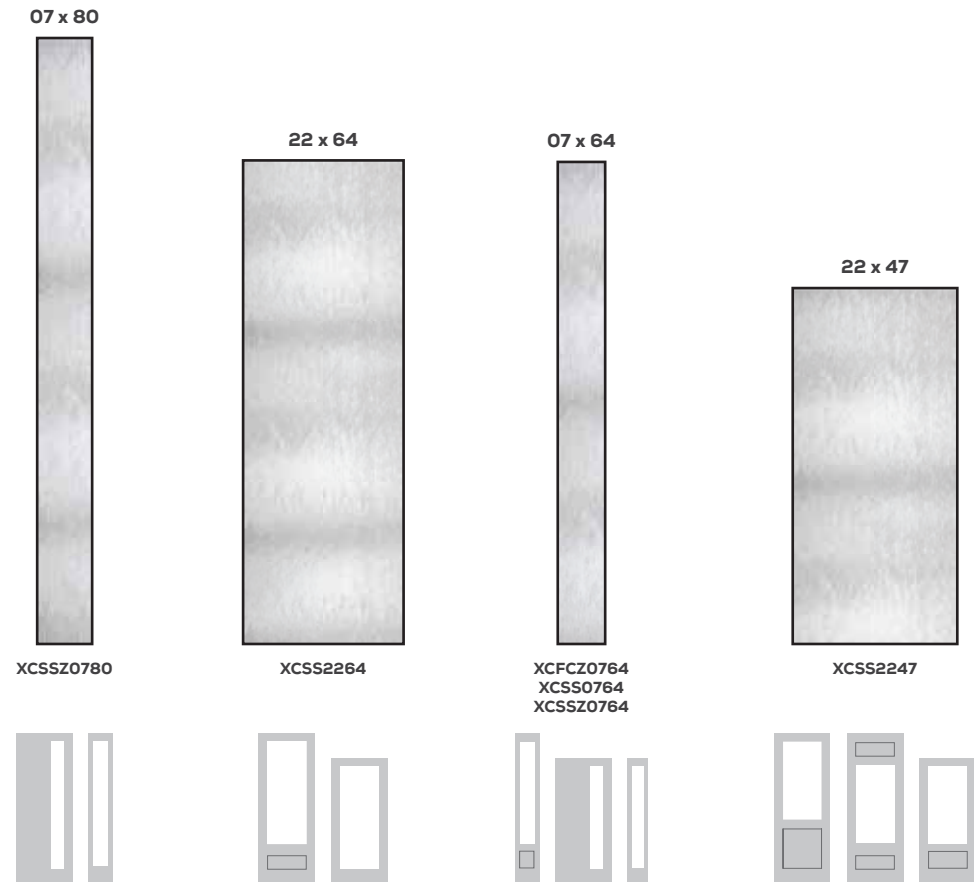

# GRANITE

Glass Privacy Rating 1 10

A coarse-grained arrangement with surface detail over the entirety of the glass.

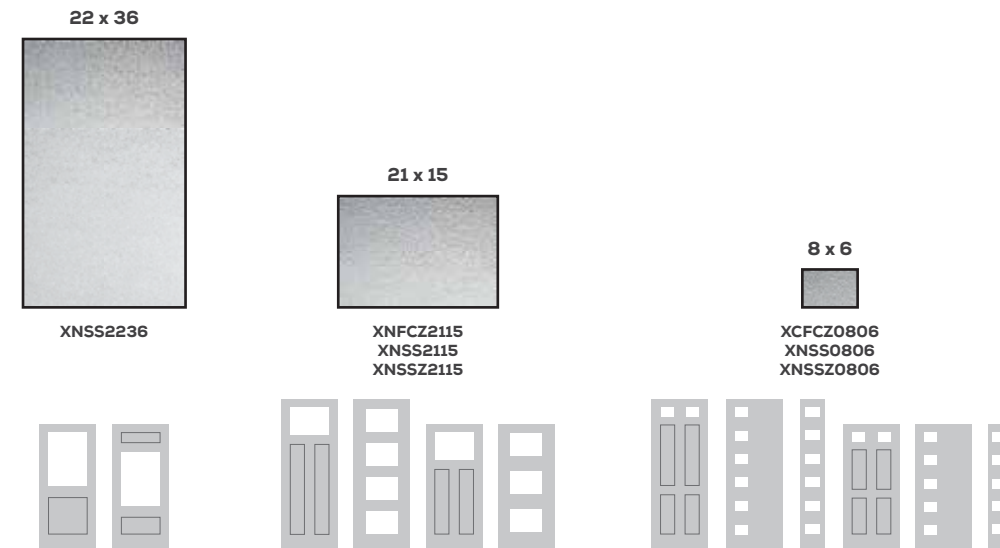
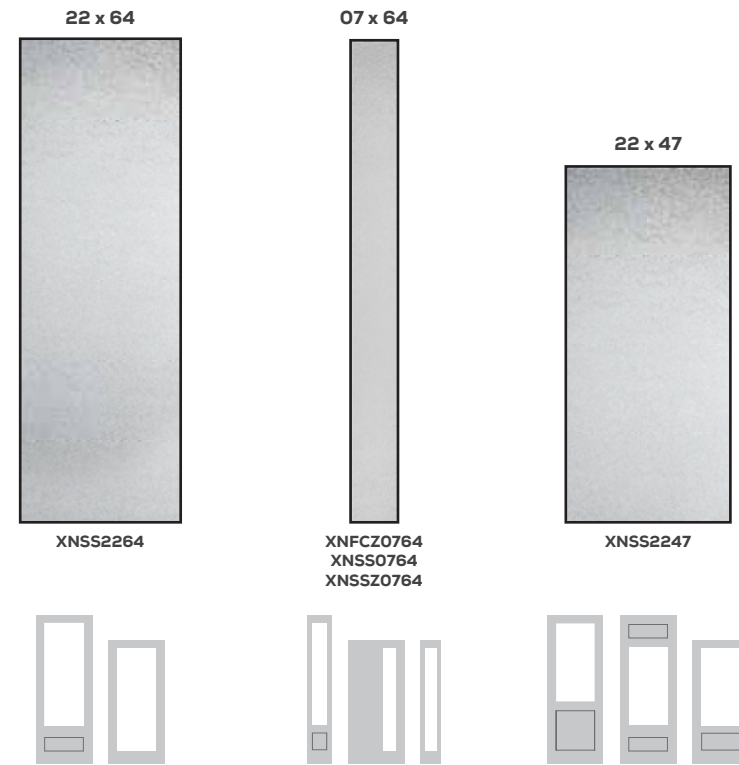

FC = BUFF  
SS = SMOOTH  
Z = FLAT FRAME

PRODUCT IMAGES SHOW EXTERIOR SIDE OF DOOR.





Boise Cascade<sup>®</sup>  
MILLWORK

## CLEAR GLASS

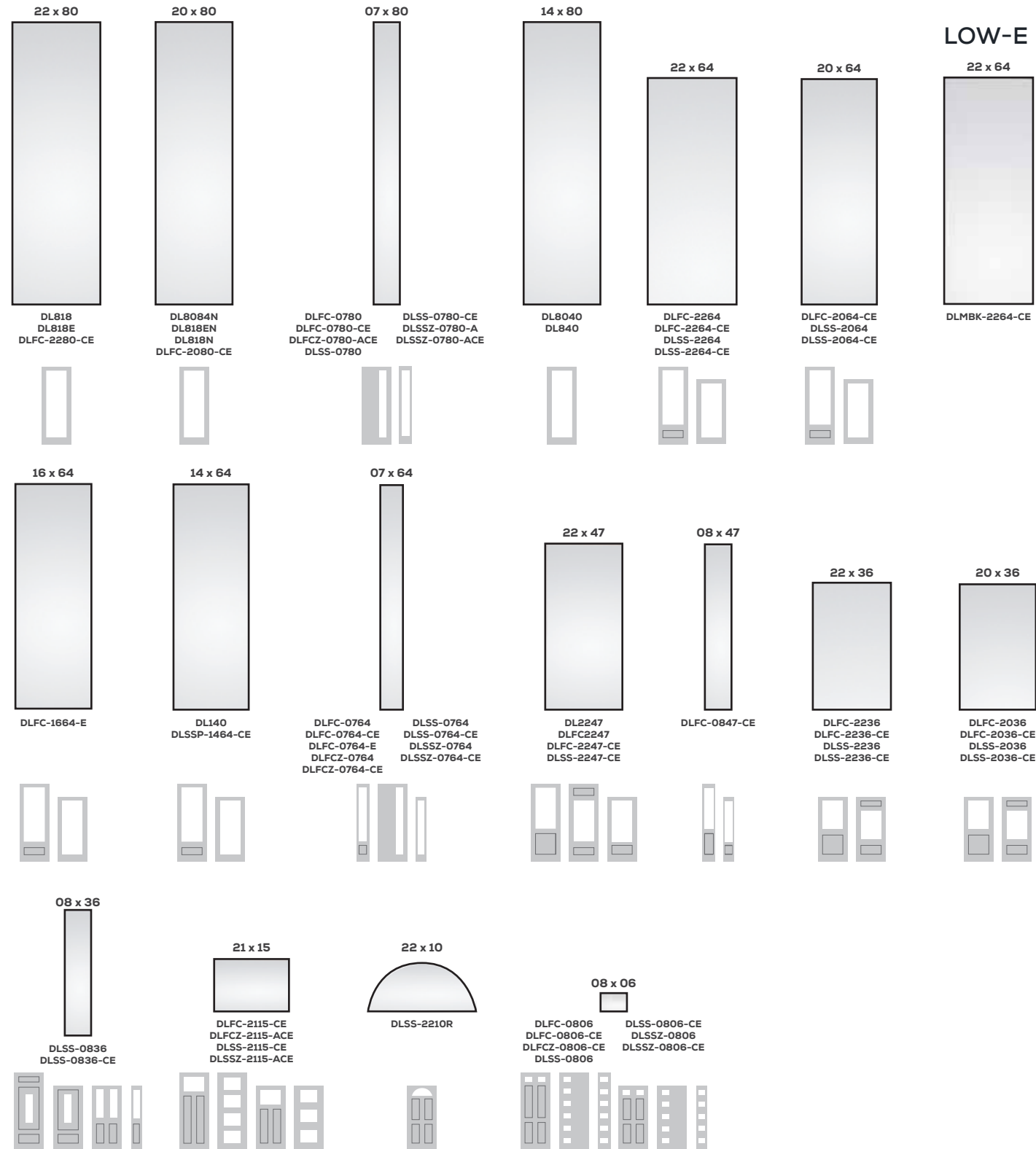

## GRILLES

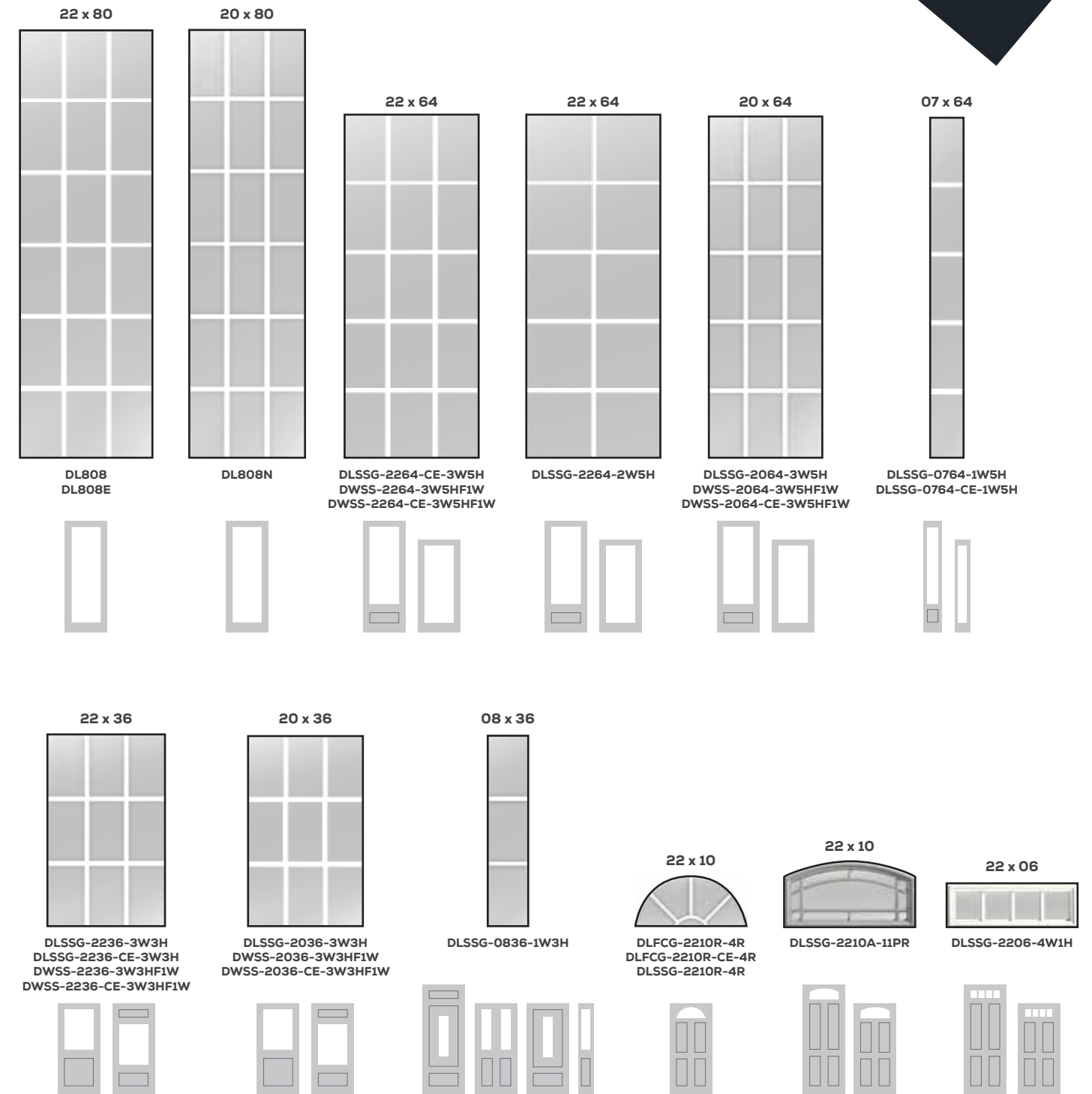

CE = LOW-E  
FC = BUFF  
SS = SMOOTH  
Z = FLAT FRAME

PRODUCT IMAGES SHOW EXTERIOR SIDE OF DOOR.



Boise Cascade<sup>®</sup>  
MILLWORK

millwork.bc.com

3130 N. Longhorn Drive, Suite 100  
Lancaster, Texas 75134  
1-833-757-0138

Stock status is subject to availability, please contact your  
Boise Cascade Millwork Representative with any questions.

THERMA TRU<sup>®</sup>  
DOORS

thermatru.com | 1-800-THERMA-TRU | 29



**JAMBS**  
Composite Jambs



4-1/8"  
4-9/16"  
5-1/4"  
6-9/16"  
7-1/4"

Description	Material	Part #	Size	Item
JAMB COMPOSITE GRAINED RAW TRIPLE W/ MULL BK	Composite	JCGN590WMU1B	9/0 5-1/4 U1	803410270
JAMB COMPOSITE SMOOTH RAW BK SKID	Composite	JCSN430U1B	3/0 4-9/16 U1	803410271
JAMB COMPOSITE SMOOTH RAW TRIPLE W/ MULL BK SKID	Composite	JCSN490WMU1B	9/0 4-9/16 U1	803410272
JAMB COMPOSITE SMOOTH RAW IS LH HD/SILL	Composite	JCSN41L80HHSG	6/8 4-9/16	803410254
JAMB COMPOSITE SMOOTH RAW IS LH HD/SILL	Composite	JCSN41L80HHSG	8/0 4-9/16	803410258
JAMB COMPOSITE SMOOTH RAW IS RH HD/SILL	Composite	JCSN41R80HHSG	6/8 4-9/16	803410255
JAMB COMPOSITE SMOOTH RAW IS RH HD/SILL	Composite	JCSN41R80HHSG	8/0 4-9/16	803410259
JAMB COMPOSITE SMOOTH RAW BK	Composite	JCSN530U1B	3/0 5-1/4 U1	803410273
JAMB COMPOSITE SMOOTH RAW TRIPLE W/ MULL BK	Composite	JCSN590WMU1B	9/0 5-1/4 U1	803410274
JAMB COMPOSITE SMOOTH RAW IS LH HB HD/SILL	Composite	JCSN51L68HHSG	6/8 5-1/4	803410275
JAMB COMPOSITE SMOOTH RAW IS LH HB HD/SILL	Composite	JCSN51L80HHSG	8/0 5-1/4	803410276
JAMB COMPOSITE SMOOTH RAW IS RH HB HD/SILL	Composite	JCSN51R68HHSG	6/8 5-1/4	803410277
JAMB COMPOSITE SMOOTH RAW IS RH HB HD/SILL	Composite	JCSN51R80HHSG	8/0 5-1/4	803410278
JAMB COMPOSITE SMOOTH RAW BK SKID	Composite	JCSN630U1B	3/0 6-9/16 U1	803410279
JAMB COMPOSITE SMOOTH RAW TRIPLE W/ MULL BK	Composite	JCSN690WMU1B	9/0 6-9/16 U1	803410280
JAMB COMPOSITE SMOOTH RAW IS LH HD/SILL	Composite	JCSN61L68HHSG	6/8 6-9/16	803410262
JAMB COMPOSITE SMOOTH RAW IS LH HD/SILL	Composite	JCSN61L80HHSG	8/0 6-9/16	803410266
JAMB COMPOSITE SMOOTH RAW IS RH HD/SILL	Composite	JCSN61R68HHSG	6/8 6-9/16	803410263
JAMB COMPOSITE SMOOTH RAW IS RH HD/SILL	Composite	JCSN61R80HHSG	8/0 6-9/16	803410267

**Other Jambs**

Description	Material	Part #	Size	Item
JAMB HEAD RUSTIC ARCH TOP FRAME	Primed Pine	JHA430U1WP	3/0 4-9/16 U1	803470000
JAMB HEAD RUSTIC ARCH TOP FRAME	Primed Pine	JHA436U1WP	3/6 4-9/16 U1	803470002
JAMB HEAD RUSTIC ARCH TOP FRAME	Primed Pine	JHA630U1WP	3/0 6-9/16 U1	803470004
JAMB HEAD RUSTIC ARCH TOP FRAME	Primed Pine	JHA636U1WP	3/6 6-9/16 U1	803470006
JAMB HEAD RUSTIC RADIUS TOP FRAME	Primed Pine	JHR430U1WP	3/0 4-9/16 U1	803470008
JAMB HEAD RUSTIC RADIUS TOP FRAME	Primed Pine	JHR436U1WP	3/6 4-9/16 U1	803470014
JAMB HEAD RUSTIC RADIUS TOP FRAME	Primed Pine	JHR630U1WP	3/0 6-9/16 U1	803470010
JAMB HEAD RUSTIC RADIUS TOP FRAME	Primed Pine	JHR636U1WP	3/6 6-9/16 U1	803470012

**FASTENERS SETTING TOOL & SCREW PLUG COVERS**

Jamb screw plugs hide unsightly screws, allowing jamb to be installed with screws through its thickest part for better aesthetics and long-term performance.

Screw plugs are available on a collated strip for ease of installation and finishing.



Description	Material	Part #	Item
JAMB PLUG COMPOSITE SMOOTH RAW	JAMB	JPCSN	803560178
JAMB PLUG INSTALLATION SCREWS	JAMB	JPSCREW	803560179
JAMB PLUG INSTALLATION TOOL	JAMB	JPTOOL	803560180

**COVE MOULD**



7/16" x 5/16" Cove Mould

Description	Application	Material	Part #	Size	Item
CELLULAR PVC COVE MOLDING FOR OS BUFF	Outswing	PVC	CPCOVMLD68F	6/8	808980045
CELLULAR PVC COVE MOLDING FOR OS BUFF	Outswing	PVC	CPCOVMLD80F	8/0	808980065
CELLULAR PVC COVE MOLDING FOR OS WHITE	Outswing	PVC	CPCOVMLD80W	8/0	808980072
COVE MOULD COMPOSITE SMOOTH RAW	Inswing	Composite	CMCSN68LN	6/8	801080327
COVE MOULD COMPOSITE SMOOTH RAW	Inswing	Composite	CMCSN80LN	8/0	801080328
REPLACEMENT COVE MOULD PRIMED PINE		Primed Pine	RPCOVMLD	82"	806040051

**BRICKMOULD**



2" Brickmould WM180

Description	Application	Material	Part #	Size	Item
BRICKMOULD COMPOSITE SMOOTH RAW IS SKID	Inswing	Composite	BMCSNI30U1	3/0 U1	800700068
BRICKMOULD COMPOSITE SMOOTH RAW IS LH HYBRID	Inswing	Composite	BMCSNIL68H	6/8	800700057
BRICKMOULD COMPOSITE SMOOTH RAW IS RH HYBRID	Inswing	Composite	BMCSNIR68H	6/8	800700058
BRICKMOULD COMPOSITE SMOOTH RAW IS	Inswing	Composite	BMCSNI28U1	2/8 U1	800700067
BRICKMOULD COMPOSITE SMOOTH RAW IS BLANK HYBRID	Inswing	Composite	BMCSNIB90WBK	9/0	800700065
BRICKMOULD COMPOSITE SMOOTH RAW IS LH HYBRID	Inswing	Composite	BMCSNIL80H	8/0	800700061
BRICKMOULD COMPOSITE SMOOTH RAW IS RH HYBRID	Inswing	Composite	BMCSNIR80H	8/0	800700062

**Additional Brickmould:**

Description	Material	Part #	Size	Item
BRICKMOULD RUSTIC ARCH TOP	Primed Pine	BMH30U1A	3/0 U1	800700013
BRICKMOULD RUSTIC ARCH TOP	Primed Pine	BMH36U1A	3/6 U1	800700018
BRICKMOULD RUSTIC RADIUS TOP	Primed Pine	BMH30U1R	3/0 U1	800700014
BRICKMOULD RUSTIC RADIUS TOP	Primed Pine	BMH36U1R	3/6 U1	800700019



## COMPOSITE ENTRY MULLION



Description	Material	Application	Part #	Size	Width	Item
MULL COMPOSITE SMOOTH RAW ENTRY NARROW IS BLANK HB HD/SILL	Composite	Inswing	MCSNENIB68HHSG	6/8	2"	804340032
MULL COMPOSITE SMOOTH RAW ENTRY WIDE IS BLANK HB HD/SILL	Composite	Inswing	MCSNEWIB68HHSG	6/8	2.5"	804340033
MULL COMPOSITE SMOOTH RAW ENTRY WIDE IS BLANK HB HD/SILL	Composite	Inswing	MCSNEWIB80HHSG	8/0	2.5"	804340034
MULL COMPOSITE SMOOTH RAW ENTRY NARROW IS BLANK HD/SILL	Composite	Inswing	MCSNENIB80HHSG	8/0	2"	804340026

## COMPOSITE PATIO MULLION



Description	Material	Application	Part #	Size	Width	Item
MULL COMPOSITE SMOOTH RAW PATIO NARROW IS BLANK HB HD/SILL	Composite	Inswing	MCSNPNIB68HHSG	6/8	2"	808980372
MULL COMPOSITE SMOOTH RAW PATIO NARROW IS BLANK HD/SILL	Composite	Inswing	MCSNPNIB80HHSG	8/0	2"	808980370
MULL COMPOSITE SMOOTH RAW PATIO WIDE IS BLANK HB HD/SILL	Composite	Inswing	MCSNPWIB80HHSG	8/0	2.5"	808980373
MULL COMPOSITE SMOOTH RAW PATIO WIDE IS BLANK HD/SILL	Composite	Inswing	MCSNPWIB68HHSG	6/8 U4	2.5"	808980374
MULL COMPOSITE SMOOTH RAW PATIO WIDE OS BLANK HB HD/SILL	Composite	Outswing	MCSNPWOB68HHSG	6/8	2.5"	804340039
MULL COMPOSITE SMOOTH RAW PATIO NARROW OS BLANK HB HD/SILL	Composite	Outswing	MCSNPNOB68HHSG	6/8	2"	804340036
MULL COMPOSITE SMOOTH RAW PATIO NARROW OS BLANK HB HD/SILL	Composite	Outswing	MCSNPNOB80HHSG	8/0	2"	804340037

### Additional Entry Mullions:

Description	Material	Application	Part #	Size	Item
MULLION PINE PATIO IS HEAD/SILL PRIMED	Primed Pine	Inswing	MNPPI79280HSGN	80" RO	804470002

## COMPOSITE MULL CASING



Description	Material	Application	Part #	Size	Width	Item
FC COMPOSITE SMOOTH RAW IS BLANK BK	Composite	Inswing	FCCSNIB30BK	3/0	3.5"	801930003
FC COMPOSITE SMOOTH RAW IS BLANK TPL W/ MULL BK	Composite	Inswing	FCCSNIB90WBK	9/0	3.5"	801930006
FC COMPOSITE SMOOTH RAW STANDARD IS BLANK BK	Composite	Inswing	FCCSNIB68B	6/8	3.5"	801930004
FC COMPOSITE SMOOTH RAW STANDARD IS BLANK BK	Composite	Inswing	FCCSNIB80B	8/0	3.5"	801930005
MULL CASING COMPOSITE SMOOTH RAW LARGE	Composite		MCCSNL80L	8/0	3.5"	804340030





**Boise Cascade**  
MILLWORK

## SILLS

Allow for a tight seal to help block wind-driven moisture infiltration at the bottom of the door and a solid stepping surface. Available in a variety of materials with features to meet the needs of different climates and exposures. Ask your Therma-Tru seller for a complete list of options.

### Sill Finishes

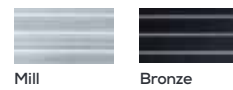

### Cap Colors

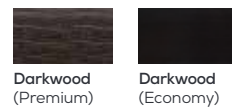

### Inswing Composite Adjustable Sill



#### Composite Adjustable Sill (Premium)

- Thick wood-grained composite cap and nosing.
- U-shaped weather seal.
- Adjustable flush stainless steel screws.
- Continuous length with spread mullion capability to fill 49"-75" rough openings.\*

Description	Application	Sill Finish	Sill Cap Color	Part #	Size	Item
IS SILL NO SCREEN ADJUSTABLE STANDARD COMPOSITE	Inswing	Bronze	Darkwood	ISL3AS5ES36UNBD	3/6 5-3/4 U1	803260263
IS SILL NO SCREEN ADJUSTABLE STANDARD COMPOSITE LINEAL	Inswing	Bronze	Darkwood	ISL3AS5EN90UNBD	9/0 5-3/4 U1	803260224
IS SILL NO SCREEN ADJUSTABLE STANDARD COMPOSITE LINEAL	Inswing	Mill	Darkwood	ISL3AS5EN90UNMD	9/0 5-3/4 U1	803260226
IS SILL NO SCREEN ADJUSTABLE STANDARD COMPOSITE	Inswing	Mill	Darkwood	ISL3AS5ES26UNMD	2/6 5-3/4 U1	803260241
IS SILL NO SCREEN ADJUSTABLE STANDARD COMPOSITE	Inswing	Mill	Darkwood	ISL3AS5ES36UNMD	3/6 5-3/4 U1	803260265
IS SILL NO SCREEN ADJUSTABLE STANDARD COMPOSITE	Inswing	Bronze	Darkwood	ISL3AS5ES28UNBD	2/8 5-3/4 U1	803260247
IS SILL NO SCREEN ADJUSTABLE STANDARD COMPOSITE	Inswing	Mill	Darkwood	ISL3AS5ES28UNMD	2/8 5-3/4 U1	803260249
IS SILL NO SCREEN ADJUSTABLE STANDARD COMPOSITE	Inswing	Bronze	Darkwood	ISL3AS5ES30UNBD	3/0 5-3/4 U1	803260255
IS SILL NO SCREEN ADJUSTABLE STANDARD COMPOSITE	Inswing	Mill	Darkwood	ISL3AS5ES30UNMD	3/0 5-3/4 U1	803260257
IS SILL NO SCREEN ADJUSTABLE STANDARD COMPOSITE W/ 7/8 ASTRAGAL	Inswing	Bronze	Darkwood	ISL3AS5EF607UNBD	6/0 5-3/4 U1	803260168
IS SILL NO SCREEN ADJUSTABLE STANDARD COMPOSITE W/ 7/8 ASTRAGAL	Inswing	Mill	Darkwood	ISL3AS5EF607UNMD	6/0 5-3/4 U1	803260170
IS SILL NO SCREEN ADJUSTABLE STANDARD COMPOSITE W/ 2 1/4" SIDELITES	Inswing	Bronze	Darkwood	ISL3AS5EL30UD14NBD	3/0 5-3/4 U1	803260184
IS SILL NO SCREEN ADJUSTABLE STANDARD COMPOSITE W/ 2 1/4" SIDELITES	Inswing	Mill	Darkwood	ISL3AS5EL30UD14NMD	3/0 5-3/4 U1	803260186
IS SILL ADJUSTABLE STANDARD COMPOSITE PATIO DOUBLE LH	Inswing	Bronze	Darkwood	ISL3AS5PD60ULNBD	6/0 5-3/4 U1	803260519
IS SILL ADJUSTABLE STANDARD COMPOSITE PATIO DOUBLE LH	Inswing	Mill	Darkwood	ISL3AS5PD60ULNMD	6/0 5-3/4 U1	803260521
IS SILL ADJUSTABLE STANDARD COMPOSITE PATIO DOUBLE RH	Inswing	Bronze	Darkwood	ISL3AS5PD60URNBD	6/0 5-3/4 U1	803260527
IS SILL ADJUSTABLE STANDARD COMPOSITE PATIO DOUBLE RH	Inswing	Mill	Darkwood	ISL3AS5PD60URNMD	6/0 5-3/4 U1	803260529
IS SILL ADJUSTABLE STANDARD COMPOSITE PATIO LINEAL	Inswing	Bronze	Darkwood	ISL3AS5PN90UNBD	9/0 5-3/4 U1	803260551
IS SILL ADJUSTABLE STANDARD COMPOSITE PATIO LINEAL	Inswing	Mill	Darkwood	ISL3AS5PN90UNMD	9/0 5-3/4 U1	803260553
IS SILL ADJUSTABLE STANDARD COMPOSITE W/ 7/8 ASTRAGAL	Inswing	Bronze	Darkwood	ISL3AS4EF607UNBD	6/0 4-9/16 U1	803260048
IS SILL ADJUSTABLE STANDARD COMPOSITE W/ 7/8 ASTRAGAL	Inswing	Mill	Darkwood	ISL3AS4EF607UNMD	6/0 4-9/16 U1	803260050
IS SILL ADJUSTABLE STANDARD COMPOSITE	Inswing	Bronze	Darkwood	ISL3AS4ES28UNBD	2/8 4-9/16 U1	803260096
IS SILL ADJUSTABLE STANDARD COMPOSITE	Inswing	Mill	Darkwood	ISL3AS4ES28UNMD	2/8 4-9/16 U1	803260098
IS SILL ADJUSTABLE STANDARD COMPOSITE	Inswing	Bronze	Darkwood	ISL3AS4ES30UNBD	3/0 4-9/16 U1	803260104
IS SILL ADJUSTABLE STANDARD COMPOSITE	Inswing	Mill	Darkwood	ISL3AS4ES30UNMD	3/0 4-9/16 U1	803260106

### Value Composite Adjustable Sill

Description	Application	Sill Finish	Sill Cap Color	Part #	Size	Item
INSWING MILL DARKWOOD	Inswing	Mill	Darkwood	ISIL3AP4ES28UNMD	2/8 4-9/16 U1	803261805
INSWING MILL DARKWOOD	Inswing	Mill	Darkwood	ISIL3AP4ES30UNMD	3/0 4-9/16 U1	803261804
INSWING BRONZE DARKWOOD	Inswing	Bronze	Darkwood	ISIL3AP4ES28UNBD	2/8 4-9/16 U1	803261807
INSWING BRONZE DARKWOOD	Inswing	Bronze	Darkwood	ISIL3AP4ES30UNBD	3/0 4-9/16 U1	803261808
INSWING MILL DARKWOOD	Inswing	Mill	Darkwood	ISIL3AP5ES28UNMD	2/8 5-3/4 U1	803261803
INSWING MILL DARKWOOD	Inswing	Mill	Darkwood	ISIL3AP5ES30UNMD	3/0 5-3/4 U1	803261798
INSWING BRONZE DARKWOOD	Inswing	Bronze	Darkwood	ISIL3AP5ES28UNBD	2/8 5-3/4 U1	803261806
INSWING BRONZE DARKWOOD	Inswing	Bronze	Darkwood	ISIL3AP5ES30UNBD	3/0 5-3/4 U1	803261799



### Outswing Composite Outswing Sill

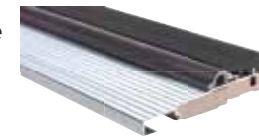

- Thick wood-grained composite cap and nosing.
- Integrated weatherstrip.

Description	Application	Sill Finish	Sill Cap Color	Part #	Size	Item
OS SILL STANDARD COMPOSITE FIXED BRONZE WEATHERSTRIP	Outswing	Bronze	Darkwood	OSE36USF5BDB	3/6 5-3/4 U1	805140272
OS SILL STANDARD COMPOSITE FIXED BRONZE WEATHERSTRIP	Outswing	Mill	Darkwood	OSE36USF5MDB	3/6 5-3/4 U1	805140274
OS SILL STANDARD COMPOSITE FIXED BRONZE WEATHERSTRIP	Outswing	Mill	Darkwood	OSE50USF5MDB	5/0 5-3/4 U1	805140352
OS SILL STANDARD COMPOSITE FIXED BRONZE WEATHERSTRIP	Outswing	Mill	Darkwood	OSE4USF5MDB	5/4 5-3/4 U1	805140400
OS SILL STANDARD COMPOSITE FIXED BRONZE WEATHERSTRIP	Outswing	Mill	Darkwood	OSE90USF5MDB	9/0 5-3/4 U1	805140688
OS SILL W/ 2 1/2" SIDELITES STANDARD COMPOSITE FIXED BRONZE WEATHERSTRIP	Outswing	Mill	Darkwood	OSE30U12SF5MDB	3/0 5-3/4 U1	805140210
OS SILL W/ 2 1/4" SIDELITES STANDARD COMPOSITE FIXED BRONZE WEATHERSTRIP	Outswing	Mill	Darkwood	OSE30U14SF5MDB	3/0 5-3/4 U1	805140218
TRU-DEFENSE OS SILL STANDARD COMPOSITE FIXED BRONZE WEATHERSTRIP	Outswing	Bronze	Darkwood	OSE28USF5BDB	2/8 5-3/4 U1	805140165
TRU-DEFENSE OS SILL STANDARD COMPOSITE FIXED BRONZE WEATHERSTRIP	Outswing	Mill	Darkwood	OSE28USF5MDB	2/8 5-3/4 U1	805140167
TRU-DEFENSE OS SILL STANDARD COMPOSITE FIXED BRONZE WEATHERSTRIP	Outswing	Bronze	Darkwood	OSE30USF5BDB	3/0 5-3/4 U1	805140224
TRU-DEFENSE OS SILL STANDARD COMPOSITE FIXED BRONZE WEATHERSTRIP	Outswing	Mill	Darkwood	OSE30USF5MDB	3/0 5-3/4 U1	805140226
TRU-DEFENSE OS SILL STANDARD COMPOSITE FIXED BRONZE WEATHERSTRIP	Outswing	Bronze	Darkwood	OSE26USF5BDB	2/6 5-3/4 U1	805140144
TRU-DEFENSE OS SILL STANDARD COMPOSITE FIXED BRONZE WEATHERSTRIP	Outswing	Bronze	Darkwood	OSE50USF5BDB	5/0 5-3/4 U1	805140350
TRU-DEFENSE OS SILL STANDARD COMPOSITE FIXED BRONZE WEATHERSTRIP	Outswing	Bronze	Darkwood	OSE4USF5BDB	5/4 5-3/4 U1	805140398
TRU-DEFENSE OS SILL STANDARD COMPOSITE FIXED BRONZE WEATHERSTRIP	Outswing	Bronze	Darkwood	OSE60USF5BDB	6/0 5-3/4 U1	805140526
TRU-DEFENSE OS SILL STANDARD COMPOSITE FIXED BRONZE WEATHERSTRIP	Outswing	Bronze	Darkwood	OSE90USF5BDB	9/0 5-3/4 U1	805140686
TRU-DEFENSE OS SILL STANDARD COMPOSITE FIXED BRONZE WEATHERSTRIP	Outswing	Mill	Darkwood	OSE60USF5MDB	6/0 5-3/4 U1	805140528
TRU-DEFENSE OS SILL W/ 2 1/2" SIDELITES STANDARD COMPOSITE FIXED BRONZE WEATHERSTRIP	Outswing	Bronze	Darkwood	OSE30U12SF5BDB	3/0 5-3/4 U1	805140208
TRU-DEFENSE OS SILL W/ 2 1/4" SIDELITES STANDARD COMPOSITE FIXED BRONZE WEATHERSTRIP	Outswing	Bronze	Darkwood	OSE30U14SF5BDB	3/0 5-3/4 U1	805140216
TRU-DEFENSE OS SILL W/ 7/8 ASTRAGAL STANDARD COMPOSITE FIXED BRONZE WEATHERSTRIP	Outswing	Bronze	Darkwood	OSE607USF5BDB	6/0 5-3/4 U1	805140510
TRU-DEFENSE OS SILL W/ 7/8 ASTRAGAL STANDARD COMPOSITE FIXED BRONZE WEATHERSTRIP	Outswing	Mill	Darkwood	OSE607USF5MDB	6/0 5-3/4 U1	805140512

### Outswing Aluminum Sill Without Thermal Break



#### Aluminum Sill with Thermal Break

- All-aluminum construction.
- Integrated weatherstrip.

Description	Application	Sill Finish	Part #	Size	Item
OS NTB SILL BRONZE	Outswing	Bronze	BS260ABU1	2/6 4-9/16 U1	800770003
OS NTB SILL BRONZE	Outswing	Bronze	BS280ABU1	2/8 4-9/16 U1	800770007
OS NTB SILL BRONZE	Outswing	Bronze	BS300ABU1	3/0 4-9/16 U1	800770011
OS NTB SILL BRONZE	Outswing	Bronze	BS600ABU1	6/0 4-9/16 U1	800770027
OS NTB SILL MILL	Outswing	Mill	BS26096U1	2/6 4-9/16 U1	800770001
OS NTB SILL MILL	Outswing	Mill	BS28096U1	2/8 4-9/16 U1	800770005
OS NTB SILL MILL	Outswing	Mill	BS30096U1	3/0 4-9/16 U1	800770009
OS NTB SILL MILL	Outswing	Mill	BS60096U1	6/0 4-9/16 U1	800770025

TRU-DEFENSE ELIGIBLE

\*SEE THE THERMA-TRU ARCHITECTURAL DETAILS & COMPONENTS MANUAL FOR ACTUAL UNIT SIZE SPECIFICATIONS.



**millwork.bc.com**  
3130 N. Longhorn Drive, Suite 100  
Lancaster, Texas 75134  
1-833-757-0138





**Boise Cascade**<sup>®</sup>  
MILLWORK

**Public Access Sill With or Without Thermal Break**  
(For ADA Applications\*\*)



- All-aluminum construction.
- Ramp slope meets Americans with Disabilities Act (ADA) requirements.

Description	Part #	Size	Item
PUBLIC ACCESS SILL - MILL FINISH	S430PAU1	3/0 4-9/16 U1	806180007
PUBLIC ACCESS SILL - MILL FINISH	S460PAU1	6/0 4-9/16 U1	806180015
PUBLIC ACCESS SILL - MILL FINISH	S630PAU1	3/0 6-9/16 U1	806190007
PUBLIC ACCESS SILL - MILL FINISH	S660PAU1	6/0 6-9/16 U1	806190015
PUBLIC ACCESS SILL NO THERMAL BREAK BRONZE	S430PABU1	3/0 4-9/16 U1	806180002
PUBLIC ACCESS SILL NO THERMAL BREAK BRONZE	S460PABU1	6/0 4-9/16 U1	806180010
PUBLIC ACCESS SILL NO THERMAL BREAK BRONZE	S630PABU1	3/0 6-9/16 U1	806190002
PUBLIC ACCESS SILL NO THERMAL BREAK BRONZE	S660PABU1	6/0 6-9/16 U1	806190010

**Sill Covers**  
(Recommended)

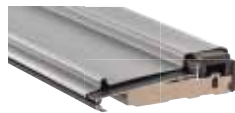

- Fits over the sill to help protect cap and finish from damage during installation.
- Made of a heavy-duty material to withstand wear.
- Available in a variety of options to fit our sills.

Shown over composite adjustable sill.

Description	Part #	Size	Item
TRU-DEFENSE OS SILL COVER BULK	TDOCOV530B	3/0 5-3/4	806800013
TRU-DEFENSE R&R SILL COVER BULK	TD3SC5300B	3/0 5-5-3/4	806800002

**Sill Extenders**

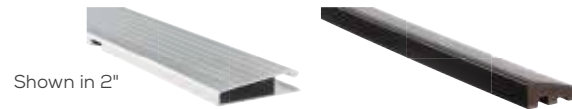

Finishes:  
Darkwood (Premium)      Sizes:  
3/4"  
2"

Description	Finish	Part #	Size	Item
TRU-DEFENSE OS SILL EXTENDER DARK WOOD	Darkwood	TDOSSN60D	2"X72	806800037
TRU-DEFENSE OS SILL EXTENDER DARK WOOD	Darkwood	TDOSSN90D	2"X108	806800041
TRU-DEFENSE SILL EXTENDER BRONZE FINISH	Bronze	SETD130X2B	2"X13/0	806261173
TRU-DEFENSE SILL EXTENDER BRONZE FINISH	Bronze	SETD30UX2B	2"X3/0 U1	806261207
TRU-DEFENSE SILL EXTENDER MILL FINISH	Mill	SETD130X2M	2"X13/0	806261174
TRU-DEFENSE SILL EXTENDER MILL FINISH	Mill	SETD30UX2M	2"X3/0 U1	806261208
TRU-DEFENSE PATIO SILL EXTENDER BRONZE FINISH	Bronze	SETD60PUX2B	2"X6/0 U1	806261239
TRU-DEFENSE PATIO SILL EXTENDER MILL FINISH	Mill	SETD60PUX2M	2"X6/0 U1	806261240

**Sill End Seal Pads**

Description	Part #	Size	Item
IS SILL PAD SLANTED END	ISL3FSEALPAD-24	1-3/8"	808980348
TRU-DEFENSE END SEAL SILL PAD	MSISSEAL-TD3		804520079
TRU-DEFENSE OS END SEAL SILL PAD	MSOSSEAL-TD		804520086

**DOOR BOTTOMS**

Designed to mate with our sills and help provide added protection to help seal the margin between the door and sill. Kerf-applied for a secure fit and made of a heavy-duty material that holds its shape to help maintain contact.

**Dual Bulb Kerf-Applied Door Bottom for Composite Adjustable, Basic Composite Adjustable, Hardwood Adjustable Sills**



Sills:  
Composite Adjustable  
Hardwood Adjustable  
Basic Composite Adjustable  
Color:  
Bronze

Description	Application	Part #	Size	Item
DOOR BOTTOM IS DP ACTIVE BRONZE	Inswing	DBDBU260B	2/6 U1	801270086
DOOR BOTTOM IS DP ACTIVE BRONZE	Inswing	DBDBU360B	3/6 U1	801270092
DOOR BOTTOM IS DP ACTIVE BRONZE 50 PER PACK	Inswing	DBDBU280B-50	2/8 U1	801270088
DOOR BOTTOM IS DP ACTIVE BRONZE 50 PER PACK	Inswing	DBDBU300B-50	3/0 U1	801270090
DOOR BOTTOM IS DP ACTIVE NOTCHED BRONZE	Inswing	DBDBU300NB	3/0 U1	801270091
DOOR BOTTOM SIDELITE IS DP ACTIVE NONOTCH BRONZE	Inswing	DBDB140B	14"	801270050

**Dual Bulb Kerf-Applied Door Bottom for Composite Adjustable, Basic Composite Adjustable, Hardwood Adjustable Sills**



Non-kerf-applied option available for replacement applications. Available in bronze only.

Description	Application	Part #	Size	Item
REPLACEMENT DOOR BOTTOM IS DP ACTIVE BRONZE	Inswing	RPDBDB300B	3/0 U1	806040053
REPLACEMENT DOOR BOTTOM IS DP ACTIVE BRONZE	Inswing	RPDBDB360B	3/6 U1	806040054

**Kerf-Applied Door Bottoms for Composite Outswing Sills**



Sills:  
Composite Outswing  
Aluminum  
Coastal  
Color:  
Bronze

Description	Application	Part #	Size	Item
DOOR BOTTOM OS ACTIVE NOHAND BRONZE	Outswing	DB30OS99U	3/0 U1	801270034
DOOR BOTTOM OS ACTIVE NOHAND BRONZE	Outswing	DB36OS99U	3/6 U1	801270042

**4 Fin Sweep Door Bottom for Public Access Sills**



Sills:  
Public Access  
Color:  
Bronze

Description	Part #	Size	Item
DOOR BOTTOM SWEEP	DB30USWP	3/0 U1	801270037
DOOR BOTTOM SWEEP	DB36USWP	3/6 U1	801270046

TRU-DEFENSE ELIGIBLE

\*\*DOOR SYSTEMS BUILT WITH PUBLIC ACCESS SILLS HAVE LITTLE RESISTANCE TO WATER PENETRATION AND HAVE A POTENTIAL TO LEAK IF INSTALLED EXPOSED TO WEATHER. WE RECOMMEND THESE SYSTEMS BE INSTALLED AWAY FROM WEATHER UNDER LARGE SOFFITS OR OVERHANGS.

Stock status is subject to availability, please contact your Boise Cascade Millwork Representative with any questions.



**millwork.bc.com**  
3130 N. Longhorn Drive, Suite 100  
Lancaster, Texas 75134  
1-833-757-0138





**Boise Cascade**  
MILLWORK

### Inactive Door Bottoms for Outswing Aluminum Sills



Sills:  
Composite Outswing  
Color:  
Bronze

Description	Application	Part #	Size	Item
DOOR BOTTOM OS INACTIVE BRONZE	Outswing	DBP30UTS	3/0	808980310

### Inactive Door Bottoms for Composite Outswing Sills

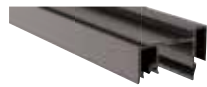

Sills:  
Composite Adjustable  
Hardwood Adjustable  
Color:  
Bronze

Description	Application	Part #	Size	Item
TRU-DEFENSE REPLACEMENT OS INACTIVE DOOR BOTTOM BRONZE	Outswing	RPOS140B	14"	806040076
TRU-DEFENSE REPLACEMENT OS INACTIVE DOOR BOTTOM BRONZE	Outswing	RPOSU300B	3/0 U1	806040089

### Inactive Door Bottoms for Composite Inswing Sills

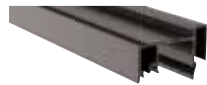

Sills:  
Composite Adjustable  
Hardwood Adjustable  
Color:  
Bronze

Description	Application	Part #	Size	Item
TRU-DEFENSE REPLACEMENT IS INACTIVE DOOR BOTTOM BRONZE	Inswing	FDBIB14B	14"	802090003
TRU-DEFENSE REPLACEMENT IS INACTIVE DOOR BOTTOM BRONZE	Inswing	FDBIB30UB	3/0	802090007

### Additional Door Bottoms Available:

Description	Application	Part #	Size	Item
REPLACEMENT DOOR BOTTOM IS DP ACTIVE BRONZE	Inswing	RPDBDB300B	3/0	806040053
REPLACEMENT DOOR BOTTOM IS DP ACTIVE BRONZE	Inswing	RPDBDB360B	3/6	806040054

## ASTRAGALS

Cover the margin between double doors to help complete the seal against air and moisture infiltration with aluminum construction for stability, holding power and durability. Available in a stainable wood-grained vinyl wrap or aluminum.

### Stainable Astragal



Heights:  
6'6"  
6'8"  
7'0"  
8'0"  
Width:  
7/8"

Configurations:  
Inswing  
Outswing  
Multi-Point Lock  
Double Bore  
Left-Handed  
Right-Handed

Grain Available:  
Fir  
Weatherstrip:  
Bronze

Description	Application	Part #	Size	Item
ASTRAGAL ALUMINUM IS BRONZE LH W/ FIR WRAP WEATHERSTRIP BRONZE LH	Inswing	ASIS0SABFL	6/8	800460016
ASTRAGAL ALUMINUM IS BRONZE LH W/ FIR WRAP WEATHERSTRIP BRONZE LH	Inswing	ASIS8SABFL	6/8	800460098
ASTRAGAL ALUMINUM IS BRONZE RH W/ FIR WRAP WEATHERSTRIP BRONZE RH	Inswing	ASIS0SABFR	8/0	800460017
ASTRAGAL ALUMINUM IS BRONZE RH W/ FIR WRAP WEATHERSTRIP BRONZE RH	Inswing	ASIS8SABFR	6/8	800460099
ASTRAGAL ALUMINUM OS W/ FIR WRAP BRONZE LH WEATHERSTRIP BRONZE LH	Outswing	ASOS0SABFL	6/6	800460177
ASTRAGAL ALUMINUM OS W/ FIR WRAP BRONZE LH WEATHERSTRIP BRONZE LH	Outswing	ASOS8SABFL	6/8	800460257
ASTRAGAL ALUMINUM OS W/ FIR WRAP BRONZE RH WEATHERSTRIP BRONZE RH	Outswing	ASOS0SABFR	8/0	800460178
ASTRAGAL ALUMINUM OS W/ FIR WRAP BRONZE RH WEATHERSTRIP BRONZE RH	Outswing	ASOS8SABFR	6/8	800460258

### Aluminum Astragal



Coastal option also available.

Heights:  
6'6"  
6'8"  
7'0"  
8'0"  
Width:  
7/8"

Configurations:  
Inswing  
Outswing  
Multi-Point Lock  
Double Bore  
Left-Handed  
Right-Handed

Grain Options:  
Bronze  
White  
Weatherstrip:  
Bronze

Description	Application	Part #	Size	Item
ASTRAGAL ALUMINUM IS STANDARD WHITE LH	Inswing	ASIS0SAAL	6/8	800460010
ASTRAGAL ALUMINUM IS STANDARD WHITE LH	Inswing	ASIS7SAAL	7/0	800460052
ASTRAGAL ALUMINUM IS STANDARD WHITE LH	Inswing	ASIS8SAAL	8/0	800460092
ASTRAGAL ALUMINUM IS STANDARD WHITE LH	Inswing	ASISPSAAL	6/6	800460137
ASTRAGAL ALUMINUM IS STANDARD WHITE RH	Inswing	ASIS0SAAR	6/8	800460012
ASTRAGAL ALUMINUM IS STANDARD WHITE RH	Inswing	ASIS7SAAR	7/0	800460053
ASTRAGAL ALUMINUM IS STANDARD WHITE RH	Inswing	ASIS8SAAR	8/0	800460094
ASTRAGAL ALUMINUM IS STANDARD WHITE RH	Inswing	ASISPSAAR	6/6	800460138
ASTRAGAL ALUMINUM OS STANDARD WHITE LH	Outswing	ASOS0SAAL	6/8	800460172
ASTRAGAL ALUMINUM OS STANDARD WHITE LH	Outswing	ASOS8SAAL	8/0	800460253
ASTRAGAL ALUMINUM OS STANDARD WHITE LH	Outswing	ASOSPSAAL	6/6	800460293
ASTRAGAL ALUMINUM OS STANDARD WHITE RH	Outswing	ASOS0SAAR	6/8	800460173
ASTRAGAL ALUMINUM OS STANDARD WHITE RH	Outswing	ASOS8SAAR	8/0	800460254
ASTRAGAL ALUMINUM OS STANDARD WHITE RH	Outswing	ASOSPSAAR	6/6	800460294

### Astragal Replacement Parts

Description	Part #	Size	Item
ASTRAGAL REPLACEMENT BOOT LH STANDARD	7ASTBOOTL450		800180000
ASTRAGAL REPLACEMENT BOOT RH STANDARD	7ASTBOOTR450		800180001
REPLACEMENT ALUMINUM ASTRAGAL HARDWARE PACKAGE	RPAHWB		806040006
REPLACEMENT ALUMINUM ASTRAGAL SPRING CLIP REP KIT	RPSPREPKIT		806040160
REPLACEMENT ASTRAGAL ALUMINUM TOP & OUTSWING BOOT 2/PK	RPTOPBT		806040198
REPLACEMENT BOLT GRIP ASSEMBLY	RPBOLTL	17"	806040024
REPLACEMENT BOLT GRIP ASSEMBLY	RPBOLTS	2-5/8"	806040026
REPLACEMENT BOLT GRIP ASSEMBLY BRONZE	RPBOLTLB	17"	806040025
REPLACEMENT BOLT GRIP ASSEMBLY BRONZE	RPBOLTSB	2-5/8"	806040027
REPLACEMENT CLOSURE STRIP WHITE	RPATRMW		806040023
REPLACEMENT SCREW BOLT RETAINER	RPAST5136016		806040019
REPLACEMENT SNAP-IN TRIM STRIP BRONZE	RPATRMB		806040022



**Boise Cascade**  
MILLWORK

millwork.bc.com  
3130 N. Longhorn Drive, Suite 100  
Lancaster, Texas 75134  
1-833-757-0138

**THERMA TRU**  
DOORS



## END RAIL

Description	Part #	Size	Item
CC REPLACEMENT KERF END RAIL	RPCCER30C	3/0	806040042
CC REPLACEMENT KERF END RAIL	RPCCER30SS	3/0	806040043
CC REPLACEMENT KERF END RAIL	RPFGERT36C	3/6	806040044
REPLACEMENT END RAIL	RPER36C	3/6	806040215
SS REPLACEMENT KERF END RAIL	RPFGERT30C	3/0	806040214
CC END RAIL FOR FULL PLANK REV V	CCER30SSPLKREVV	3/0	800920027



## WEATHERSTRIP

Engineered in a variety of profiles for a precise seal between the door and frame. Made of a flexible protected by a durable jacket to resist moisture and wear.

### Medium-Reach Weatherstrip



Colors:  
Bronze  
White

### Long-Reach Weatherstrip



Colors:  
Bronze  
White

Description	Part #	Size	Color	Item
WEATHERSTRIP HEAD LONG REACH 37"	WHFB	3/0	Bronze	807830001
WEATHERSTRIP HEAD MEDIUM REACH 38"	WHFB7	3/0	Bronze	807830004
WEATHERSTRIP SIDE LONG REACH 81"	WSFB	6/8	Bronze	807950015
WEATHERSTRIP SIDE LONG REACH	WS8FB	8/0	Bronze	807950006
WEATHERSTRIP SIDE LONG REACH	WS8FW	8/0	White	807950012
WEATHERSTRIP SIDE MEDIUM REACH 81"	WSFB7	6/8	Bronze	807950018
WEATHERSTRIP SIDE MEDIUM REACH 97"	WS8FB7	8/0	Bronze	807950008
WEATHERSTRIP SIDE MEDIUM REACH 97"	WS8FW7	8/0	White	807950014

## HINGES

Hinges position the door to properly compress the weatherstrip and help ensure smooth operation. Features options to suit various applications and mate with mortise pockets machined into our doors.

### Classic Craft Ball-Bearing Staggered Hole Pattern Hinge



Description	Finish	Part #	Size	Item
CC NRP HINGE BALL BEARING STAGGERED	Brushed Nickel	HGBCCSR5NRP-1C	5/8	802790079
CC NRP HINGE BALL BEARING STAGGERED	Black Nickel	HGBCCSR5NRP-1D	5/8	802790080
CC NRP HINGE BALL BEARING STAGGERED	Rubbed Bronze	HGBCCSR5NRP-1H	5/8	802790081
CC NRP HINGE BALL BEARING STAGGERED	Yellow Zinc	HGBCCSR5NRP-1Y	5/8	802790082
CC HINGE BALL BEARING STAGGERED	Brushed Nickel	HGBCCR5S-1C	5/8	802790083
CC HINGE BALL BEARING STAGGERED	Black Nickel	HGBCCR5S-1D	5/8	802790084
CC HINGE BALL BEARING STAGGERED	Rubbed Bronze	HGBCCR5S-1H	5/8	802790085
CC HINGE BALL BEARING STAGGERED	Yellow Zinc	HGBCCR5S-1Y	5/8	802790086





**Boise Cascade**  
MILLWORK

Self-Aligning Ball-Bearing Hinge



Description	Finish	Part #	Size	Item
HINGE BALL BEARING RH	Black Nickel	HGBBR5-1D	5/8"	802790061
HINGE BALL BEARING RH	Brushed Nickel	HGBBR5-1C	5/8"	802790060
HINGE BALL BEARING RH	Oil-Rubbed Bronze	HGBBR5-1H	5/8"	802790062
HINGE BALL BEARING RH	Yellow Zinc	HGBBR5-YZ	5/8"	802790067
HINGE BALL BEARING LH	Black Nickel	HGBBL5-1D	5/8"	802790052
HINGE BALL BEARING LH	Brushed Nickel	HGBBL5-1C	5/8"	802790051
HINGE BALL BEARING LH	Oil-Rubbed Bronze	HGBBL5-1H	5/8"	802790053
HINGE BALL BEARING LH	Yellow Zinc	HGBBL5-YZ	5/8"	802790058

Self-Aligning Hinge



Description	Finish	Part #	Size	Item
HINGE NRP BULK PACK	Black Nickel	HG58RP-1D-S	5/8"	802790011
HINGE NRP BULK PACK	Brushed Nickel	HG58RP-1C-S	5/8"	802790010
HINGE NRP BULK PACK	Oil-Rubbed Bronze	HG58RP-1H-S	5/8"	802790012
HINGE NRP BULK PACK	Yellow Zinc	HG58RPYZ-S	5/8"	802790015
HINGE BULK PACK	Brushed Nickel	HG58-1C-S	5/8"	802790008
HINGE SELF ALIGNING BULK PACK	Oil-Rubbed Bronze	HG58-1H-S	5/8"	802790009
HINGE ASSEMBLED LH	Yellow Zinc	HG58YZLA	5/8"	802790027
HINGE ASSEMBLED RH	Yellow Zinc	HG58YZRA	5/8"	802790028

Spring-Loaded Hinge



Description	Finish	Part #	Size	Item
HINGE SPRING LOADED	Black Nickel	HG58SL-1D	5/8"	802790017
HINGE SPRING LOADED	Brushed Nickel	HG58SL-1C	5/8"	802790016
HINGE SPRING LOADED	Oil-Rubbed Bronze	HG58SL-1H	5/8"	802790018
HINGE SPRING LOADED	Yellow Zinc	HG58SLYZ	5/8"	802790022

**HANDLESETS**

Designed to complement Therma-Tru door styles from traditional to contemporary.

Available Handleset Finishes



Grip Style Handlesets

**Forte**



Description	Finish	Part #	Locking	Item
HANDLESET GRIP STYLE FORTE	Black Nickel	MPGSGTHS2016-1D	Active	804490291
HANDLESET GRIP STYLE FORTE	Brushed Nickel	MPGSGTHS2016-1C	Active	804490290
HANDLESET GRIP STYLE GEAR TONGUE FORTE	Oil-Rubbed Bronze	MPGSGTHS2016-1H	Active	804490273

**Prospect**



Description	Finish	Part #	Locking	Item
HANDLESET GRIP STYLE GEAR TONGUE PROSPECT	Oil-Rubbed Bronze	MPGSGTHS1986-1H	Active	804490274
HANDLESET GRIP STYLE PROSPECT	Black Nickel	MPGSGTHS1986-1D	Active	804490289
HANDLESET GRIP STYLE PROSPECT	Brushed Nickel	MPGSGTHS1986-1C	Active	804490288

Lever Style Handlesets

**Heirloom**



Description	Finish	Part #	Locking	Backplate	Item
HANDLESET HEIRLOOM	Black Nickel	MPTS112374-1D	Active	Narrow	804490203
HANDLESET HEIRLOOM	Black Nickel	MPTS1123965N-1D	Active	Wide	804490210
HANDLESET HEIRLOOM	Brushed Nickel	MPTS112374-1C	Active	Narrow	804490202
HANDLESET HEIRLOOM	Brushed Nickel	MPTS1123965N-1C	Active	Wide	804490209
HANDLESET HEIRLOOM	Oil-Rubbed Bronze	MPTS112374-1H	Active	Narrow	804490204
HANDLESET HEIRLOOM	Oil-Rubbed Bronze	MPTS1123965N-1H	Active	Wide	804490211
HANDLESET HEIRLOOM	Black Nickel	DTS112374-1D	Inactive	Narrow	801480016
HANDLESET HEIRLOOM	Black Nickel	DTS1123965N-1D	Inactive	Wide	801480023
HANDLESET HEIRLOOM	Brushed Nickel	DTS112374-1C	Inactive	Narrow	801480015
HANDLESET HEIRLOOM	Brushed Nickel	DTS1123965N-1C	Inactive	Wide	801480022
HANDLESET HEIRLOOM	Oil-Rubbed Bronze	DTS112374-1H	Inactive	Narrow	801480017
HANDLESET HEIRLOOM	Oil-Rubbed Bronze	DTS1123965N-1H	Inactive	Wide	801480024

Note: Grip Style Handlesets and Lever Style Handlesets are not interchangeable.



**Boise Cascade**  
MILLWORK

**millwork.bc.com**  
3130 N. Longhorn Drive, Suite 100  
Lancaster, Texas 75134  
1-833-757-0138

**THERMA TRU**  
DOORS





**Boise Cascade**  
MILLWORK

**Millennium**



Backplates:  
Wide  
Narrow  
Locking:  
Active  
Inactive

Description	Finish	Part #	Locking	Backplate	Item
HANDLESET MILLENNIUM	Black Nickel	MPTS151216-1D	Active	Narrow	804490217
HANDLESET MILLENNIUM	Black Nickel	MPTS1513955N-1D	Active	Wide	804490224
HANDLESET MILLENNIUM	Brushed Nickel	MPTS151216-1C	Active	Narrow	804490216
HANDLESET MILLENNIUM	Brushed Nickel	MPTS1513955N-1C	Active	Wide	804490223
HANDLESET MILLENNIUM	Oil-Rubbed Bronze	MPTS151216-1H	Active	Narrow	804490218
HANDLESET MILLENNIUM	Oil-Rubbed Bronze	MPTS1513955N-1H	Active	Wide	804490225
HANDLESET MILLENNIUM	Black Nickel	DTS151216-1D	Inactive	Narrow	801480030
HANDLESET MILLENNIUM	Black Nickel	DTS1513955N-1D	Inactive	Wide	801480037
HANDLESET MILLENNIUM	Brushed Nickel	DTS151216-1C	Inactive	Narrow	801480029
HANDLESET MILLENNIUM	Brushed Nickel	DTS1513955N-1C	Inactive	Wide	801480036
HANDLESET MILLENNIUM	Oil-Rubbed Bronze	DTS151216-1H	Inactive	Narrow	801480031
HANDLESET MILLENNIUM	Oil-Rubbed Bronze	DTS1513955N-1H	Inactive	Wide	801480038

**Venture**



Description	Finish	Part #	Locking	Backplate	Item
HANDLESET VENTURE	Black Nickel	MPTS1020374-1D	Active	Narrow	804490189
HANDLESET VENTURE	Black Nickel	MPTS10203965N-1D	Active	Wide	804490196
HANDLESET VENTURE	Brushed Nickel	MPTS1020374-1C	Active	Narrow	804490188
HANDLESET VENTURE	Brushed Nickel	MPTS10203965N-1C	Active	Wide	804490195
HANDLESET VENTURE	Oil-Rubbed Bronze	MPTS1020374-1H	Active	Narrow	804490190
HANDLESET VENTURE	Oil-Rubbed Bronze	MPTS10203965N-1H	Active	Wide	804490197
HANDLESET VENTURE	Black Nickel	DTS1020374-1D	Inactive	Narrow	801480002
HANDLESET VENTURE	Black Nickel	DTS10203965N-1D	Inactive	Wide	801480009
HANDLESET VENTURE	Brushed Nickel	DTS1020374-1C	Inactive	Narrow	801480001
HANDLESET VENTURE	Brushed Nickel	DTS10203965N-1C	Inactive	Wide	801480008
HANDLESET VENTURE	Oil-Rubbed Bronze	DTS1020374-1H	Inactive	Narrow	801480003
HANDLESET VENTURE	Oil-Rubbed Bronze	DTS10203965N-1H	Inactive	Wide	801480010

**SPEAKEASY'S**

**Mahogany & Grilles**

Item	Description
809027821	Mahogany Speakeasy Clear IG
809027817	Standard Grille
809027815	Balfour Grille



Mahogany Speakeasy  
Clear IG

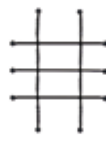

Standard  
Grille



Balfour  
Grille

**Iron**

Item	Description
809029008	Standard Grille w/ Seedy Glass
809029011	Decorative Grille w/ Seedy Glass



Standard Grille  
w/ Seedy Glass



Decorative Grille  
w/ Seedy Glass

**HARDWARE**

**Security Strike Plate**

Adjustable security strike plate wraps around the jamb and engages the frame for added support and strength, and resistance against forced entry.



Description	Application	Finish	Part #	Item
TRU-DEFENSE ADJUSTABLE SECURITY STRIKE PLATE ASTRAGAL/MULLION		Black Nickel	MSAJSSPTD-1D	804520044
TRU-DEFENSE ADJUSTABLE SECURITY STRIKE PLATE ASTRAGAL/MULLION		Brushed Nickel	MSAJSSPTD-1C	804520043
TRU-DEFENSE ADJUSTABLE SECURITY STRIKE PLATE ASTRAGAL/MULLION		Oil-Rubbed Bronze	MSAJSSPTD-1H	804520045
TRU-DEFENSE ADJUSTABLE SECURITY STRIKE PLATE ASTRAGAL/MULLION		Yellow Zinc	MSAJSSPTD-YZ	804520050
TRU-DEFENSE ADJUSTABLE SECURITY STRIKE PLATE JAMB		Black Nickel	MS00SSPTD-1D	804520014
TRU-DEFENSE ADJUSTABLE SECURITY STRIKE PLATE JAMB		Brushed Nickel	MS00SSPTD-1C	804520013
TRU-DEFENSE ADJUSTABLE SECURITY STRIKE PLATE JAMB		Oil-Rubbed Bronze	MS00SSPTD-1H	804520015
TRU-DEFENSE ADJUSTABLE SECURITY STRIKE PLATE JAMB		Yellow Zinc	MS00SSPTD-YZ	804520020
TRU-DEFENSE ASTRAGAL STRIKE PACKAGE SHOOTBOLT IS	Inswing	Black Nickel	MPMSBASIS3-1D	804490098
TRU-DEFENSE ASTRAGAL STRIKE PACKAGE SHOOTBOLT IS	Inswing	Brushed Nickel	MPMSBASIS3-1C	804490097
TRU-DEFENSE ASTRAGAL STRIKE PACKAGE SHOOTBOLT IS	Inswing	Oil-Rubbed Bronze	MPMSBASIS3-1H	804490099
TRU-DEFENSE ASTRAGAL STRIKE PACKAGE SHOOTBOLT OS	Outswing	Black Nickel	MPMSBOSIS-1D	804490115
TRU-DEFENSE ASTRAGAL STRIKE PACKAGE SHOOTBOLT OS	Outswing	Brushed Nickel	MPMSBOSIS-1C	804490114
TRU-DEFENSE ASTRAGAL STRIKE PACKAGE SHOOTBOLT OS	Outswing	Oil-Rubbed Bronze	MPMSBOSIS-1H	804490116
ADJUSTABLE SECURITY STRIKE PLATE ASTRAGAL/MULLION		Black Nickel		804520044
ADJUSTABLE SECURITY STRIKE PLATE ASTRAGAL/MULLION		Brass	MSAJSSP	804520050
ADJUSTABLE SECURITY STRIKE PLATE ASTRAGAL/MULLION		Brushed Nickel	MSAJSSP-1C	804520043
ADJUSTABLE SECURITY STRIKE PLATE ASTRAGAL/MULLION		Oil-Rubbed Bronze	MSAJSSP-1H	804520045
HANDLESET MPLS GRIP STYLE GEAR TONGUE CAPTURED STRIKE PACKAGE		Black Nickel	MPGSGTCS-1D	804490295
HANDLESET MPLS GRIP STYLE GEAR TONGUE CAPTURED STRIKE PACKAGE		Brushed Nickel	MPGSGTCS-1C	808980079
HANDLESET MPLS GRIP STYLE GEAR TONGUE CAPTURED STRIKE PACKAGE		Oil-Rubbed Bronze	MPGSGTCS-1H	804490294
MPLS TONGUE STRIKE PACKAGE CURVED LIP		Black Nickel	MPMARTS-1D	804490077
MPLS TONGUE STRIKE PACKAGE CURVED LIP		Brushed Nickel	MPMARTS-1C	804490076
MPLS TONGUE STRIKE PACKAGE CURVED LIP		Oil-Rubbed Bronze	MPMARTS-1H	804490078

**Strike Plate Screws**

Description	Finish	Part #	Item
SCREW PACKAGE A	Yellow Zinc	MSSCRPA	804520088
SCREW PACKAGE A	Black Nickel	MSSCRPA-1D	804520090
SCREW PACKAGE A	Brushed Nickel	MSSCRPA-1C	804520089



**Boise Cascade**  
MILLWORK

**millwork.bc.com**  
3130 N. Longhorn Drive, Suite 100  
Lancaster, Texas 75134  
1-833-757-0138

Stock status is subject to availability, please contact your  
Boise Cascade Millwork Representative with any questions.





**Boise Cascade**  
MILLWORK

### Storm Door Adaptor

6-9/16" Base Adaptor

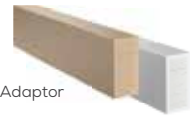

Description	Part #	Size	Item
LONG STORM DOOR ADAPTOR	BACSN680L	8/0 6-9/16	800570009

### Rain Protection

Helps repel moisture away from areas exposed to wind-driven moisture infiltration enhancing weather protection. Highly recommended for applications directly exposed to wind and rain.



**Rain Deflector**  
(Inswing):  
Colors:  
Bronze  
White

**Rain Guard** ✚  
(Outswing):  
Colors:  
Bronze  
White

Description	Part #	Size	Color	Item
OS RAIN GUARD HEAD BRONZE	RGPF30B	3/0	Bronze	805930000
RAIN DEFLECTOR BRONZE	HPRD30UB	3/0 U1	Bronze	802900003
RAIN DEFLECTOR WHITE	HPRD30UW	3/0 U1	White	802900005

### DOOR & LITE DIVIDER BARS

Wood-grained or smooth SDL bars adhere to the interior and exterior panes of tempered glass and can be stained or painted to complement the door and home. 4-1/4" and 5-1/2" flat profile bars are also used on solid-panel doors as door divider bars.

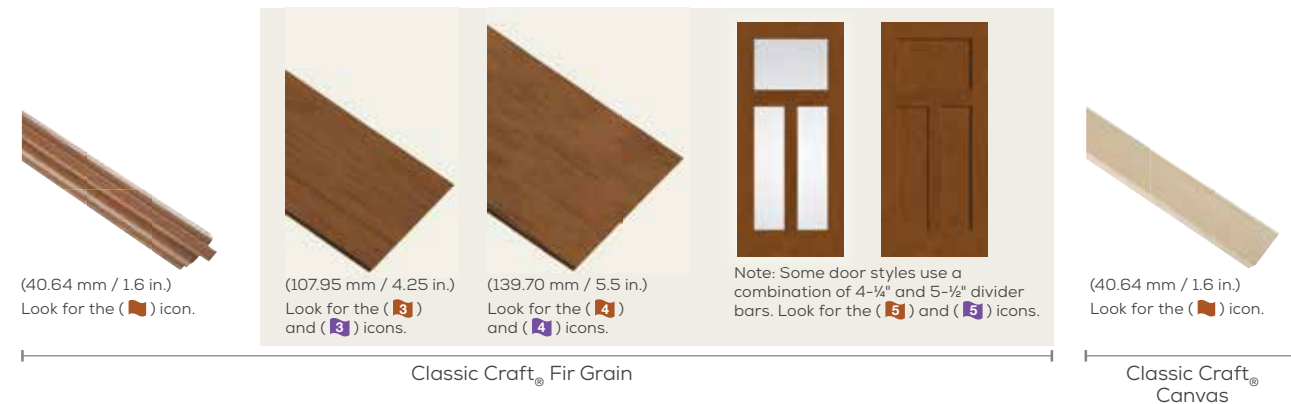

Description	Part #	Width	Item
CCA 24 PIECE DOOR VERTICAL DIVIDER PACK For use with 3'6" Flush-Glazed Doors.	CCA36LD3024V24	1.6"	800920004
CCA 4-LITE DOOR DIVIDER KIT 1 PER PACK For use with 3'6" Flush-Glazed Doors.	CCALD3024L4-1	1.6"	800920014
CCA 6-LITE DOOR DIVIDER KIT 1 PER PACK For use with 3'6" Flush-Glazed Doors.	CCALD3024L6-1	1.6"	800920015
CCA STYLE LITE DIVIDER 4-LITE DOOR PACKAGE 1 PER PACK Contains 2 vertical and 4 horizontal pieces (1 door).	CCALD2618L4-1	1.6"	800920011
CCA STYLE LITE DIVIDER 6-LITE DOOR PACKAGE 1 PER PACK Contains 2 vertical and 6 horizontal pieces (1 door).	CCALD2618L6-1	1.6"	800920012
CCA STYLE LITE DIVIDER SIDELITE LONG HORIZONTAL 20-PACK Contains 20 long horizontal pieces.	CCALDSLHL20	1.6"	800920016
CCA STYLE LITE DIVIDER VERTICAL 24-PACK For use with 26" x 66" and 26" x 80" shaker flush-glazed doors and opaque 1 panel shaker.	CCALD2618V24	1.6"	800920013
CCS W1 5.5 DOOR/LITE DIVIDER LINEAL BULK PACK For use with 26" x 66" and 26" x 80" shaker flush-glazed doors and opaque 1 panel shaker.	CCS5LD86-6	5.5"	800952277
CCS W1 DOOR/LITE DIVIDER LINEAL BULK PACK For use with 26" x 66" and 26" x 80" shaker flush-glazed doors and opaque 1 panel shaker.	CCS4LD86-6	4.25"	800952276
CCV LITE DIVIDER SIDELITE HORIZONTAL 20 PER PACK	CCVLDLH-20	1.6"	800960463

### ACCESSORIES

#### Clavos & Strap Hinges

Add a finishing touch of rustic flavor with decorative hardware in an authentic, hand-forged wrought iron look with a black finish. Includes Pyramid and round clavos as well as strap hinges.



Description	Part #	Size	Item
CLAVOS SQUARE BLACK	CLVSBL100SAB20	1"	801070001
CLAVOS SQUARE BLACK	CLVSBL125SAB20	1-1/4"	801070003
CLAVOS SQUARE BLACK	CLVSBL150SAB20	1-1/2"	801070004
CLAVOS ROUND BLACK	CLVSBL100RAB20	1"	801070000
CLAVOS ROUND BLACK	CLVSBL125RAB20	1-1/4"	801070002
CLAVOS ROUND BLACK	CLVSBL175RAB20	1-3/4"	801070005
STRAP HINGE BLACK	STRPHSD183	18"	806680005

#### Dentil Shelves

Complete the look with a dentil shelf for true Craftsman appeal or to complement other architectural elements around the house. Includes 4- and 16-block options.

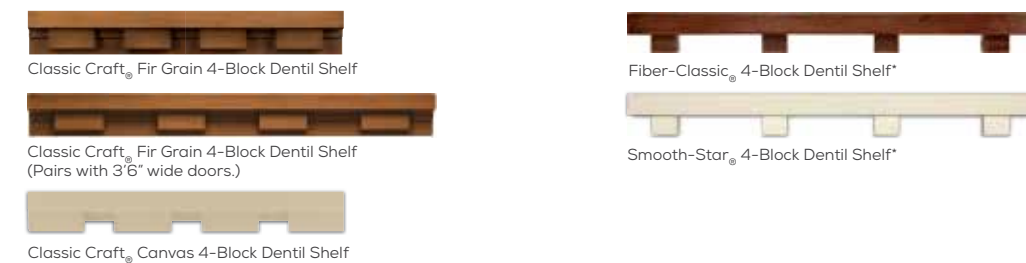

Description	Part #	Size	Item
CCA 4-BLOCK DENTIL SHELF	CCADS04	26.2"	800920007
CCA 4-BLOCK DENTIL SHELF	CCA36DS04	35.1"	800920002
CCV 4-BLOCK DENTIL SHELF	CCVDS04	25.8"	800960459

Description	Part #	Size	Item
FC DENTIL SHELF	DSB4BLK	26.2"	801460175
SS DENTIL SHELF	DSW4BLK	25.4"	801460176

#### Corner Seal Pads

Fit securely behind weatherstrip and mate with our inswing sills to help block wind-driven moisture from pushing through the corner and up the frame. (Not required for outswing sills.)

#### Classic Craft<sub>®</sub> 7-Shape Pads ✚

Colors:  
Bronze  
White

Sills:  
Composite Adjustable  
Hardwood Adjustable  
Basic Composite Adjustable  
Public Access



#### Fiber-Classic<sub>®</sub> / Smooth-Star<sub>®</sub> 7-Shape Pads ✚

Colors:  
Bronze  
White

Sills:  
Composite Adjustable  
Hardwood Adjustable  
Basic Composite Adjustable  
Public Access



Description	Part #	Color	Item
CC TRU-DEFENSE CORNER SEAL PAD PACKAGE LH BRONZE	CCCPPKLB	Bronze	800920020
CC TRU-DEFENSE CORNER SEAL PAD PACKAGE RH BRONZE	CCCPPKRB	Bronze	800920023
FC/SS TRU-DEFENSE CORNER SEAL PAD PACKAGE BRONZE	CPPKB	Bronze	801120010

#### Transport Clips

Description	Part #	Item
TRANSPORT CLIP	MS00TPC	804520021

✚ TRU-DEFENSE ELIGIBLE

\* NOT RECOMMENDED FOR USE BEHIND STORM DOORS OR TO BE PAINTED DARK COLORS, IF EXPOSED TO DIRECT SUNLIGHT.



**Boise Cascade**  
MILLWORK

millwork.bc.com

3130 N. Longhorn Drive, Suite 100  
Lancaster, Texas 75134  
1-833-757-0138

**THERMA TRU**  
DOORS

thermatru.com | 1-800-THERMA-TRU | 48



Boise Cascade<sup>®</sup>  
MILLWORK

## MAHOGANY EXTERIOR DOORS

All Okoume Mahogany exterior doors and sidelights are 1-3/4" thick, come standard with UltraBlock<sup>®</sup> technology and are stocked in the sizes noted.



**7002**  
Low-E  
2'6", 2'8",  
3'0" x 6'8"  
2'6", 2'8",  
3'0" x 8'0"



**7403 Shaker**  
Satin Etch IG  
3'0" x 6'8"



**7404 Shaker**  
Satin Etch IG  
3'0" x 6'8"



**7405 Shaker**  
Satin Etch IG  
3'0" x 8'0"



**7501**  
DHRP and  
Low-E  
3'0" x 6'8"  
3'0" x 8'0"



**7801**  
DHRP and  
Low-E  
12", 14" x 6'8"  
12", 14" x 8'0"



**7501**  
DHRP and  
Seedy  
Baroque IG  
3'0" x 6'8"  
3'0" x 8'0"



**7501**  
DHRP and  
White  
Laminate IG  
3'0" x 6'8"  
3'0" x 8'0"



**9541**  
Dentil Shelf  
for 3'0" doors



**37504**  
DHRP and  
Low-E  
3'0" x 6'8"  
3'0" x 8'0"



**37802**  
DHRP and  
Low-E  
12", 14" x 6'8"  
12", 14" x 8'0"



**37504**  
DHRP and Seedy  
Baroque IG  
3'0" x 6'8"  
3'0" x 8'0"



**37504**  
DHRP and  
White  
Laminate IG  
3'0" x 6'8"  
3'0" x 8'0"



**37506**  
DHRP and  
Low-E  
3'0" x 6'8"  
3'0" x 8'0"



**37803**  
DHRP and  
Low-E  
12", 14" x 6'8"  
12", 14" x 8'0"



**37506**  
DHRP and Seedy  
Baroque IG  
3'0" x 6'8"  
3'0" x 8'0"



**37506**  
DHRP and White  
Laminate IG  
3'0" x 6'8"  
3'0" x 8'0"



**7504**  
DHRP and  
Low-E Bevel  
3'0" x 6'8"  
3'0" x 8'0"



**7802**  
DHRP and  
Low-E Bevel  
12", 14" x 6'8"  
12", 14" x 8'0"



**7506**  
DHRP and Low-E  
Bevel  
2'6", 2'8", 3'0" x 6'8"  
2'6", 2'8", 3'0" x 8'0"



**7803**  
DHRP and  
Low-E Bevel  
12", 14" x 6'8"  
12", 14" x 8'0"



**37508**  
DHRP and  
Low-E  
3'0" x 6'8"  
3'0" x 8'0"



**37804**  
DHRP and  
Low-E  
12", 14" x 6'8"  
12", 14" x 8'0"



**37508**  
DHRP and Seedy  
Baroque IG  
3'0" x 6'8"  
3'0" x 8'0"



**7506 Double Arch Top Unit**  
DHRP and Low-E Bevel  
5'0" x 8'0"  
5'4" x 8'0"  
6'0" x 8'0"



**37508**  
DHRP and White  
Laminate IG  
3'0" x 6'8"  
3'0" x 8'0"



**6801**  
DHRP and  
Low-E  
3'0" x 6'8"  
3'0" x 8'0"



**6175**  
DHRP and  
Low-E  
12", 14" x 6'8"  
12", 14" x 8'0"



**6801**  
DHRP and White  
Laminate IG  
3'0" x 6'8"  
3'0" x 8'0"



**6801**  
DHRP and Seedy  
Baroque IG  
3'0" x 6'8"  
3'0" x 8'0"



DHRP = 1-7/16" DOUBLE HIP-RAISED PANEL  
FP = 3/4" FLAT PANEL  
IG = 3/4" INSULATED GLAZING  
SG = 1/8" SINGLE GLAZED



Boise Cascade<sup>®</sup>  
MILLWORK

millwork.bc.com

3130 N. Longhorn Drive, Suite 100  
Lancaster, Texas 75134  
1-833-757-0138

Stock status is subject to availability, please contact your  
Boise Cascade Millwork Representative with any questions.

Simpson<sup>®</sup>  
Door Company

SIMPSONDOOR.COM | 800 SIMPSON | #SIMPSONDOOR



**Boise Cascade**  
MILLWORK

## WESTERN HEMLOCK EXTERIOR DOORS

All Western Hemlock exterior doors and sidelights are 1-3/4" thick, come standard with UltraBlock® technology and are stocked in the sizes noted.



<b>7002</b> Clear IG 2'0", 2'6", 2'8", 3'0" x 6'8" 2'0", 2'6", 2'8", 3'0" x 8'0"	<b>7701</b> Clear IG 12", 14" x 6'8" 12", 14" x 8'0"	<b>7002 Shaker</b> Clear IG 2'0", 2'6", 2'8", 3'0" x 6'8"	<b>7701 Shaker</b> Clear IG 12", 14" x 6'8" 12", 14" x 8'0"	<b>7002</b> Low-E 2'0", 2'6", 2'8", 3'0" x 6'8" 2'0", 2'6", 2'8", 3'0" x 8'0"	<b>7701</b> Low-E 12", 14" x 6'8" 12", 14" x 8'0"	<b>7002 Shaker</b> Low-E 2'0", 2'6", 2'8", 3'0" x 6'8" 2'0", 2'6", 2'8", 3'0" x 8'0"	<b>7701 Shaker</b> Low-E 12", 14" x 6'8" 12", 14" x 8'0"	<b>7002</b> ADA Compliant Low-E 3'0" x 6'8" 3'0" x 7'0" 3'0" x 8'0"
---	---	--	--	--	--	---	---	--



<b>7002</b> WaterBarrier® with Low-E 2'6", 2'8", 3'0" x 6'8" 2'6", 2'8", 3'0" x 8'0"	<b>7037</b> Low-E 3'0" x 6'8"	<b>37010</b> Low-E 2'0", 2'6", 2'8", 3'0" x 6'8" 2'6", 2'8", 3'0" x 8'0"	<b>37010 Shaker</b> Low-E 2'0", 2'6", 2'8", 3'0" x 6'8" 2'6", 2'8", 3'0" x 8'0"	<b>37010</b> WaterBarrier® with Low-E 2'6", 2'8", 3'0" x 6'8" 2'6", 2'8", 3'0" x 8'0"	<b>37010 Shaker</b> WaterBarrier® with Low-E 2'6", 2'8", 3'0" x 6'8" 2'6", 2'8", 3'0" x 8'0"	<b>37015</b> Clear IG 2'6", 2'8", 3'0" x 6'8"	<b>7501</b> DHRP and Low-E 3'0" x 6'8" 3'0", 3'6" x 8'0"	<b>7801</b> DHRP and Low-E 12", 14" x 6'8" 12", 14" x 8'0"
--	-------------------------------------	---	--	---	--	--	--	--



<b>7501</b> DHRP and Seedy Baroque IG 3'0" x 6'8" 3'0" x 8'0"	<b>7501</b> DHRP and White Laminate IG 3'0" x 6'8" 3'0" x 8'0"	<b>37598</b> DHRP and Low-E 3'0" x 6'8" 3'0" x 8'0"
---	--	---



<b>37504</b> DHRP and Low-E 3'0" x 6'8" 3'0", 3'6" x 8'0"	<b>37802</b> DHRP and Low-E 12", 14" x 6'8" 12", 14" x 8'0"	<b>37504</b> DHRP and Seedy Baroque IG 3'0" x 6'8" 3'0" x 8'0"	<b>37504</b> DHRP and White Laminate IG 3'0" x 6'8" 3'0" x 8'0"
---	---	--	---

## WESTERN HEMLOCK EXTERIOR DOORS (CONTINUED)

All Western Hemlock exterior doors and sidelights are 1-3/4" thick, come standard with UltraBlock® technology and are stocked in the sizes noted.



<b>37506</b> DHRP and Low-E 3'0" x 6'8" 3'0", 3'6" x 8'0"	<b>37803</b> DHRP and Low-E 12", 14" x 6'8" 12", 14" x 8'0"	<b>37506</b> DHRP and Seedy Baroque IG 3'0" x 6'8" 3'0" x 8'0"	<b>37506</b> DHRP and White Laminate IG 3'0" x 6'8" 3'0" x 8'0"	<b>37508</b> DHRP and Low-E 3'0" x 6'8" 3'0", 3'6" x 8'0"	<b>37804</b> DHRP and Low-E 12", 14" x 6'8" 12", 14" x 8'0"	<b>37508</b> DHRP and Seedy Baroque IG 3'0" x 6'8" 3'0" x 8'0"	<b>9541</b> Dentil Shelf for 3'0" and 3'6" doors
---	---	---	--	---	---	--	--



<b>37508</b> DHRP and White Laminate IG 3'0" x 6'8" 3'0" x 8'0"	<b>7031</b> DHRP and Low-E 2'8", 3'0" x 6'8"	<b>37435</b> DHRP and Low-E 2'8", 3'0" x 6'8"	<b>37035</b> DHRP and Low-E 2'8", 3'0" x 6'8"	<b>7044</b> DHRP and Low-E 2'8", 3'0" x 6'8"	<b>37444</b> DHRP and Low-E 2'8", 3'0" x 6'8"	<b>37944</b> DHRP and Low-E 2'8", 3'0" x 6'8"
---	--	--	--	---	--	--



<b>6801</b> DHRP and Low-E 3'0" x 6'8" 3'0", 3'6" x 8'0"	<b>6175</b> DHRP and Low-E 12", 14" x 6'8" 12", 14" x 8'0"	<b>6801 Shaker</b> FP and Low-E 3'0" x 6'8" 3'0" x 8'0"	<b>6175 Shaker</b> FP and Low-E 12", 14" x 6'8" 12", 14" x 8'0"	<b>6801</b> DHRP and White Laminate IG 3'0" x 6'8" 3'0" x 8'0"	<b>6801 Shaker</b> FP and White Laminate IG 3'0" x 6'8" 3'0" x 8'0"	<b>6801</b> DHRP and Seedy Baroque IG 3'0" x 6'8" 3'0" x 8'0"	<b>6801 Shaker</b> FP and Seedy Baroque IG 3'0" x 6'8" 3'0" x 8'0"
--	--	---	---	--	---	---	--



<b>7132</b> DHRP and Low-E 2'8", 3'0" x 6'8"	<b>37134</b> DHRP and Low-E 2'8", 3'0" x 6'8"	<b>7344</b> DHRP 2'8", 3'0" x 6'8" 2'8", 3'0" x 8'0"	<b>7130</b> DHRP 2'8", 3'0" x 6'8" 2'8", 3'0" x 8'0"	<b>1510</b> Clear SG, No UltraBlock® 2'0", 2'4", 2'6", 2'8", 3'0" x 6'8"	<b>1515</b> Clear SG, No UltraBlock® 2'6", 2'8", 3'0" x 6'8"
--	--	---	---	--	--

DHRP = 1-7/16" DOUBLE HIP-RAISED PANEL  
IG = 3/4" INSULATED GLAZING



**Boise Cascade**  
MILLWORK

millwork.bc.com  
3130 N. Longhorn Drive, Suite 100  
Lancaster, Texas 75134  
1-833-757-0138

**Simpson**  
Door Company

SIMPSONDOOR.COM | 800 SIMPSON | #SIMPSONDOOR



Boise Cascade<sup>®</sup>  
MILLWORK

## KNOTTY ALDER EXTERIOR DOORS

All Knotty Alder exterior doors and sidelights are 1-3/4" thick, come standard with UltraBlock<sup>®</sup> technology and are stocked in the sizes noted.

























			
<b>7002</b> Low-E 2'0", 2'6", 2'8", 3'0" x 6'8" 2'0", 2'6", 2'8", 3'0" x 8'0"	<b>37010</b> Low-E 2'0", 2'6", 2'8", 3'0" x 6'8" 2'6", 2'8", 3'0" x 8'0"	<b>7501</b> DHRP and Low-E 3'0" x 6'8" 3'0", 3'6" x 8'0"	<b>7801</b> DHRP and Low-E 12", 14" x 6'8" 12", 14" x 8'0"
			
<b>7501</b> DHRP and Seedy Baroque IG 3'0" x 6'8" 3'0" x 8'0"	<b>7501</b> DHRP and White Laminate IG 3'0" x 6'8" 3'0" x 8'0"	<b>37504</b> DHRP and Low-E 3'0" x 6'8" 3'0", 3'6" x 8'0"	<b>37802</b> DHRP and Low-E 12", 14" x 6'8" 12", 14" x 8'0"

								
<b>37504</b> DHRP and Seedy Baroque IG 3'0" x 6'8" 3'0" x 8'0"	<b>37504</b> DHRP and White Laminate IG 3'0" x 6'8" 3'0" x 8'0"	<b>37506</b> DHRP and Low-E 3'0" x 6'8" 3'0", 3'6" x 8'0"	<b>37803</b> DHRP and Low-E 12", 14" x 6'8" 12", 14" x 8'0"	<b>37506</b> DHRP and Seedy Baroque IG 3'0" x 6'8" 3'0" x 8'0"	<b>37506</b> DHRP and White Laminate IG 3'0" x 6'8" 3'0" x 8'0"	<b>37508</b> DHRP and Low-E 3'0" x 6'8" 3'0", 3'6" x 8'0"	<b>37804</b> DHRP and Low-E 12", 14" x 6'8" 12", 14" x 8'0"	<b>37508</b> DHRP and Seedy Baroque IG 3'0" x 6'8" 3'0" x 8'0"
								
<b>37508</b> DHRP and White Laminate IG 3'0" x 6'8" 3'0" x 8'0"	<b>36806</b> DHRP and Low-E 3'0" x 6'8" 3'0" x 8'0"	<b>36806 Shaker</b> FP and Low-E 3'0" x 6'8" 3'0" x 8'0"	<b>36806</b> DHRP and Seedy Baroque IG 3'0" x 6'8" 3'0" x 8'0"	<b>36806 Shaker</b> FP and Seedy Baroque IG 3'0" x 6'8" 3'0" x 8'0"	<b>36806</b> DHRP and White Laminate IG 3'0" x 6'8" 3'0" x 8'0"	<b>36806 Shaker</b> FP and White Laminate IG 3'0" x 6'8" 3'0" x 8'0"	<b>9541</b> Dentil Shelf for 3'0" and 3'6" doors	

## REDI-PRIME<sup>®</sup> INTERIOR DOORS

All Redi-Prime<sup>®</sup> interior doors are 1-3/8" thick and are stocked in the sizes noted. Redi-Prime fire-rated doors are stocked 1-3/4" thick.

						
<b>8720</b> Shaker 3/8" FP 1'3", 1'4", 1'6", 2'0", 2'4", 2'6", 2'8", 3'0" x 6'8" 1'4", 1'6", 2'0", 2'4", 2'6", 2'8", 3'0" x 8'0"	<b>89320</b> Shaker 1-3/4" Fire-Rated 3/4" FP 2'8", 3'0" x 6'8" 2'8", 3'0" x 8'0"	<b>8782</b> Shaker 3/8" FP 1'6", 2'0", 2'4", 2'6", 2'8", 3'0" x 6'8" 1'4", 1'6", 2'0", 2'4", 2'6", 2'8", 3'0" x 8'0"	<b>89382</b> Shaker 1-3/4" Fire- Rated 3/4" FP 2'8", 3'0" x 6'8" 2'8", 3'0" x 8'0"	<b>8780</b> Shaker Plantation Louver 1'6", 2'0", 2'4", 2'6", 2'8", 3'0" x 6'8"		
						
<b>8781</b> Shaker Plantation Louver 3/8" FP 1'6", 2'0", 2'4", 2'6", 2'8", 3'0" x 6'8"	<b>8730</b> Shaker 3/8" FP 1'6", 2'0", 2'4", 2'6", 2'8", 3'0" x 6'8" 1'4", 1'6", 2'0", 2'4", 2'6", 2'8", 3'0" x 8'0"	<b>89330</b> Shaker 1-3/4" Fire-Rated 3/4" FP 2'8", 3'0" x 6'8" 2'8", 3'0" x 8'0"	<b>8760</b> Shaker 3/8" FP 1'3", 1'4", 1'6", 2'0", 2'4", 2'6", 2'8", 3'0" x 6'8" 1'6", 2'0", 2'4", 2'6", 2'8", 3'0" x 8'0"	<b>89360</b> Shaker 1-3/4" Fire-Rated 3/4" FP 2'8", 3'0" x 6'8" 2'8", 3'0" x 8'0"	<b>8755</b> Shaker 3/8" FP 1'4", 1'6", 2'0", 2'4", 2'6", 2'8", 3'0" x 6'8" 1'4", 1'6", 2'0", 2'4", 2'6", 2'8", 3'0" x 8'0"	<b>89355</b> Shaker 1-3/4" Fire-Rated 3/4" FP 2'8", 3'0" x 6'8" 2'8", 3'0" x 8'0"
						
<b>89801</b> Shaker Full Plank Barn Door w/ V-Groove 3'0", 3'6" x 7'0" 3'0", 3'6" x 8'4"	<b>89812</b> Shaker Z Pattern Barn Door w/ V-Groove 3'0", 3'6" x 7'0" 3'0", 3'6" x 8'4"	<b>89815</b> Shaker K Pattern Barn Door w/ V-Groove 3'0", 3'6" x 7'0" 3'0", 3'6" x 8'4"	<b>8001</b> Clear SG 2'0", 2'4", 2'6", 2'8", 3'0" x 6'8" 2'0", 2'4", 2'6", 2'8", 3'0" x 8'0"	<b>8001</b> Shaker Clear SG 2'0", 2'4", 2'6", 2'8", 3'0" x 6'8" 2'0", 2'4", 2'6", 2'8", 3'0" x 8'0"		
						
<b>8411</b> White Laminate 2'0", 2'4", 2'6", 2'8", 3'0" x 6'8" 2'0", 2'4", 2'6", 2'8", 3'0" x 8'0"	<b>8411</b> Shaker Quirk White Laminate 2'0", 2'4", 2'6", 2'8", 3'0" x 6'8" 2'0", 2'4", 2'6", 2'8", 3'0" x 8'0"	<b>8475</b> V-Groove 2'0" x 6'8" = 10-lite layout 2'4", 2'6", 2'8", 3'0" x 6'8" = 15-lite layout	<b>8490</b> Pantry 2'0", 2'4", 2'6", 2'8", 3'0" x 6'8"	<b>8490 (8'0")</b> Pantry with 3/8" FP 2'0", 2'4", 2'6", 2'8", 3'0" x 8'0"	<b>8010</b> Clear SG 2'0", 2'4", 2'6", 2'8", 3'0" x 6'8"	



Boise Cascade<sup>®</sup>  
MILLWORK

millwork.bc.com  
3130 N. Longhorn Drive, Suite 100  
Lancaster, Texas 75134  
1-833-757-0138

DHRP = 1-7/16" DOUBLE HIP-RAISED PANEL  
FP = 3/4" FLAT PANEL  
IG = 3/4" INSULATED GLAZING  
SG = 1/8" SINGLE GLAZED

Stock status is subject to availability, please contact your  
Boise Cascade Millwork Representative with any questions.

Simpson<sup>®</sup>  
Door Company

SIMPSONDOOR.COM | 800 SIMPSON | #SIMPSONDOOR



## REDI-PRIME<sup>®</sup> INTERIOR DOORS (CONTINUED)

All Redi-Prime<sup>®</sup> interior doors are 1-3/8" thick and are stocked in the sizes noted. Fire-rated doors are stocked 1-3/4" thick.



**8012**  
Clear SG  
2'0", 2'4", 2'6",  
2'8", 3'0" x 6'8"



**8015**  
Clear SG  
2'4", 2'6", 2'8",  
3'0" x 6'8"



**8018**  
Clear SG  
2'6", 2'8",  
3'0" x 8'0"



**8733 Shaker**  
Clear SG  
2'0", 2'4", 2'6",  
2'8", 3'0" x 6'8"



**8733 Shaker**  
White Laminate  
2'0", 2'4", 2'6",  
2'8", 3'0" x 6'8"



**8735 Shaker**  
Clear SG  
2'0", 2'4", 2'6",  
2'8", 3'0" x 6'8"  
2'0", 2'4", 2'6",  
2'8", 3'0" x 8'0"



**8735 Shaker**  
White Laminate  
2'0", 2'4", 2'6",  
2'8", 3'0" x 6'8"  
2'0", 2'4", 2'6",  
2'8", 3'0" x 8'0"

## WESTERN HEMLOCK INTERIOR DOORS

All Western Hemlock interior doors are 1-3/8" thick and are stocked in the sizes noted. Fire-rated doors are stocked 1-3/4" thick.



**720 Shaker**  
3/8" FP  
1'6", 2'0", 2'4",  
2'6", 2'8",  
3'0" x 6'8"  
1'6", 2'0", 2'4",  
2'6", 2'8",  
3'0" x 8'0"



**9320 Shaker**  
1-3/4" Fire-  
Rated  
3/4" FP  
2'8", 3'0" x 6'8"  
2'8", 3'0" x 8'0"



**782 Shaker**  
3/8" FP  
1'6", 2'0", 2'4",  
2'6", 2'8",  
3'0" x 6'8"  
1'6", 2'0", 2'4",  
2'6", 2'8",  
3'0" x 8'0"



**9382 Shaker**  
1-3/4" Fire-  
Rated  
3/4" FP  
2'8", 3'0" x 6'8"  
2'8", 3'0" x 8'0"



**730 Shaker**  
3/8" FP  
1'6", 2'0", 2'4",  
2'6", 2'8",  
3'0" x 6'8"



**9330 Shaker**  
1-3/4" Fire-Rated  
3/4" FP  
2'8", 3'0" x 6'8"



**760 Shaker**  
3/8" FP  
1'6", 2'0", 2'4",  
2'6", 2'8",  
3'0" x 6'8"



**9360 Shaker**  
1-3/4" Fire-Rated  
3/4" FP  
2'8", 3'0" x 6'8"



**755 Shaker**  
3/8" FP  
1'6", 2'0", 2'4",  
2'6", 2'8",  
3'0" x 6'8"  
1'6", 2'0", 2'4",  
2'6", 2'8",  
3'0" x 8'0"



**9355 Shaker**  
1-3/4" Fire-  
Rated  
3/4" FP  
2'8", 3'0" x 6'8"  
2'8", 3'0" x 8'0"



**1310**  
Clear SG  
2'0", 2'4", 2'6",  
2'8", 3'0" x 6'8"



**1312**  
Clear SG  
2'0", 2'4", 2'6",  
2'8", 3'0" x 8'0"



**1315**  
Clear SG  
2'6", 2'8",  
3'0" x 6'8"



**1318**  
Clear SG  
2'6", 2'8",  
3'0" x 8'0"



**1643 Shaker**  
Clear SG  
2'0", 2'4", 2'6",  
2'8", 3'0" x 6'8"



**1643 Shaker**  
White Laminate  
2'0", 2'4", 2'6", 2'8",  
3'0" x 6'8"



**1645 Shaker**  
Clear SG  
2'0", 2'4", 2'6",  
2'8", 3'0" x 6'8"



**1645 Shaker**  
White Laminate  
2'0", 2'4", 2'6",  
2'8", 3'0" x 6'8"



**55**  
3/4" RP  
1'6", 2'0", 2'4",  
2'6", 2'8",  
3'0" x 6'8"



**9255**  
1-3/4" Fire-  
Rated 1-7/16"  
RP 2'8", 3'0"  
x 6'8"



**1501**  
Clear SG  
2'0", 2'4", 2'6",  
2'8", 3'0" x 6'8"  
2'0", 2'4", 2'6",  
2'8", 3'0" x 8'0"



**1501 Shaker**  
Clear SG  
2'0", 2'4", 2'6",  
2'8", 3'0" x 6'8"  
2'0", 2'4", 2'6",  
2'8", 3'0" x 8'0"



**1501**  
White Laminate  
2'0", 2'4", 2'6", 2'8",  
3'0" x 6'8"  
2'0", 2'4", 2'6", 2'8",  
3'0" x 8'0"



**1501 Shaker Quirk**  
White Laminate  
2'0", 2'4", 2'6", 2'8",  
3'0" x 6'8" 2'0", 2'4",  
2'6", 2'8", 3'0" x 8'0"



**1590**  
Pantry  
2'0", 2'4", 2'6"  
x 6'8"



**1590 (8'0)**  
Pantry with  
3/4" RP  
2'0", 2'4", 2'6",  
2'8" x 8'0"



**1593**  
Laundry with  
3/4" RP  
2'8", 3'0" x 6'8"

SG = SINGLE GLAZED  
FP = FLAT PANEL  
RP = RAISED PANEL













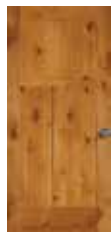

**Boise Cascade**  
MILLWORK

## KNOTTY ALDER INTERIOR DOORS

All Knotty Alder interior doors are 1-3/8" thick and are stocked in the sizes noted.  
Fire-rated doors are stocked 1-3/4" thick.











				
<b>760 Shaker</b> 3/8" FP 16", 20", 24", 26", 28", 30" x 6'8" 16", 20", 24", 26", 28", 30" x 8'0"	<b>9360 Shaker</b> 1-3/4" Fire-Rated 3/4" FP 28", 30" x 6'8" 28", 30" x 8'0"	<b>755 Shaker</b> 3/8" FP 16", 20", 24", 26", 28", 30" x 6'8"	<b>9355 Shaker</b> 1-3/4" Fire- Rated 3/4" FP 28", 30" x 6'8"	<b>82</b> 3/4" RP 16", 20", 24", 26", 28", 30" x 6'8", 16", 20", 24", 26", 28", 30" x 8'0"
				
<b>7282</b> 1-3/4" 1-7/16" RP 20", 24", 26", 28", 30" x 6'8" 16", 20", 24", 26", 28", 30", 36" x 8'0"	<b>7282</b> 1-3/4" V-Groove 1-7/16" RP 20", 24", 26", 28", 30" x 6'8" 16", 20", 24", 26", 28", 30", 36" x 8'0"	<b>465</b> 3/4" RP 16", 20", 24", 26", 28", 30" x 6'8" 16", 20", 24", 26", 28", 30" x 8'0"	<b>9265</b> 1-3/4" Fire-Rated 1-7/16" RP 28", 30" x 6'8" 28", 30" x 8'0"	<b>465</b> V-Groove 3/4" RP 16", 20", 24", 26", 28", 30" x 6'8", 16", 20", 24", 26", 28", 30" x 8'0"

		
<b>720 Shaker</b> 3/8" FP 16", 20", 24", 26", 28", 30" x 6'8"	<b>9320 Shaker</b> 1-3/4" Fire- Rated 3/4" FP 28", 30" x 6'8"	<b>782 Shaker</b> 3/8" FP 16", 20", 24", 26", 28", 30" x 6'8", 16", 20", 24", 26", 28", 30" x 8'0"
		
<b>9382 Shaker</b> 1-3/4" Fire-Rated 3/4" FP 28", 30" x 6'8" 28", 30" x 8'0"	<b>730 Shaker</b> 3/8" FP 16", 20", 24", 26", 28", 30" x 6'8"	<b>9330 Shaker</b> 1-3/4" Fire-Rated 3/4" FP 28", 30" x 6'8"

## KNOTTY ALDER INTERIOR DOORS (CONTINUED)

All Knotty Alder interior doors are 1-3/8" thick and are stocked in the sizes noted.  
Fire-rated doors are stocked 1-3/4" thick.

					
<b>80801 Shaker Full Plank</b> Barn Door w/ V-Groove 3'0", 3'6" x 7'0" 3'0", 3'6" x 8'4"	<b>80812 Shaker Z Pattern</b> Barn Door w/ V-Groove 3'0", 3'6" x 7'0" 3'0", 3'6" x 8'4"	<b>80815 Shaker K Pattern</b> Barn Door w/ V-Groove 3'0", 3'6" x 7'0" 3'0", 3'6" x 8'4"	<b>1501</b> Clear SG 2'0", 2'4", 2'6", 2'8", 3'0" x 6'8" 2'0", 2'4", 2'6", 2'8", 3'0" x 8'0"	<b>1501 Shaker</b> Clear SG 2'0", 2'4", 2'6", 2'8", 3'0" x 6'8"	<b>1501</b> White Laminate 2'0", 2'4", 2'6", 2'8", 3'0" x 6'8" 2'0", 2'4", 2'6", 2'8", 3'0" x 8'0"
					
<b>1501 Shaker Quirk</b> White Laminate 2'0", 2'4", 2'6", 2'8", 3'0" x 6'8"	<b>1590</b> Pantry 2'0", 2'4", 2'6", x 6'8"	<b>1593</b> Laundry with 3/4" RP 2'8", 3'0" x 6'8"			



SG = SINGLE GLAZED  
FP = FLAT PANEL  
RP = RAISED PANEL

Stock status is subject to availability, please contact your Boise Cascade Millwork Representative with any questions.



**Boise Cascade**  
MILLWORK

[millwork.bc.com](http://millwork.bc.com)  
3130 N. Longhorn Drive, Suite 100  
Lancaster, Texas 75134  
1-833-757-0138

**Simpson**  
Door Company









































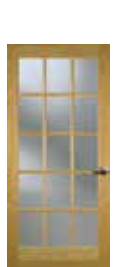
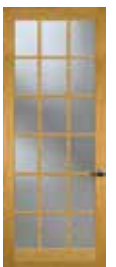

SIMPSONDOOR.COM | 800 SIMPSON | #SIMPSONDOOR

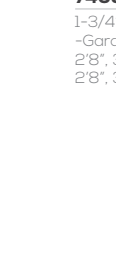
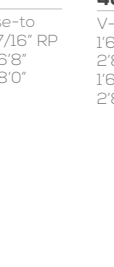

Boise Cascade<sup>®</sup>  
MILLWORK

## PINE INTERIOR DOORS

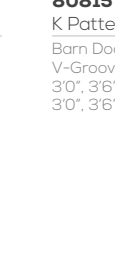
Southern Yellow Pine interior doors are stocked 1-3/8" with panel door designs also stocked 1-3/4" for your house-to-garage application. Stock sizes are also noted.

								
<b>720 Shaker</b> 3/8" FP 16", 20", 24", 26", 28", 30" x 6'8"	<b>70720 Shaker</b> 1-3/4" House-to -Garage 3/4" FP 28", 30" x 6'8"	<b>782 Shaker</b> 3/8" FP 16", 20", 24", 26", 28", 30" x 6'8"	<b>70782 Shaker</b> 1-3/4" House-to -Garage 3/4" FP 28", 30" x 6'8"	<b>760 Shaker</b> 3/8" FP 16", 20", 24", 26", 28", 30" x 6'8"	<b>70760 Shaker</b> 1-3/4" House-to -Garage 3/4" FP 28", 30" x 6'8"	<b>755 Shaker</b> 3/8" FP 16", 20", 24", 26", 28", 30" x 6'8"	<b>70755 Shaker</b> 1-3/4" House-to -Garage 3/4" FP 28", 30" x 6'8"	<b>82</b> 3/4" RP 16", 20", 24", 26", 28", 30" x 6'8", 16", 20", 24", 26", 28", 30" x 8'0"
								
<b>7282</b> 1-3/4" House-to- Garage 1-7/16" RP 28", 30" x 8'0"	<b>82</b> V-Groove 3/4" RP 16", 20", 24", 26", 28", 30" x 6'8", 16", 20", 24", 26", 28", 30" x 8'0"	<b>7282</b> 1-3/4" House-to -Garage, V-Groove 1-7/16" RP 28", 30" x 6'8", 28", 30" x 8'0"	<b>465</b> 3/4" RP 16", 20", 24", 26", 28", 30" x 6'8", 16", 20", 24", 26", 28", 30" x 8'0"	<b>7465</b> 1-3/4" House-to -Garage 1-7/16" RP 28", 30" x 6'8", 28", 30" x 8'0"	<b>465</b> V-Groove 3/4" RP 16", 20", 24", 26", 28", 30" x 6'8", 16", 20", 24", 26", 28", 30" x 8'0"	<b>7465</b> 1-3/4" House-to -Garage, V-Groove 1-7/16" RP 28", 30" x 6'8", 28", 30" x 8'0"	<b>44</b> 3/4" RP 16", 20", 24", 26", 28", 30" x 6'8"	<b>7344</b> 1-3/4" House-to -Garage 1-7/16" RP 28", 30" x 6'8"
								
<b>66</b> 3/4" RP 16", 20", 24", 26", 28", 30" x 6'8", 16", 20", 24", 26", 28", 30" x 8'0"	<b>7130</b> 1-3/4" House-to -Garage 1-7/16" RP 28", 30" x 6'8", 28", 30" x 8'0"	<b>1501</b> Clear SG 20", 24", 26", 28", 30" x 6'8", 20", 24", 26", 28", 30" x 8'0"	<b>1501 Shaker</b> Clear SG 20", 24", 26", 28", 30" x 6'8", 20", 24", 26", 28", 30" x 8'0"	<b>1501</b> White Laminate 20", 24", 26", 28", 30" x 6'8", 20", 24", 26", 28", 30" x 8'0"	<b>1501 Shaker Quirk</b> White Laminate 20", 24", 26", 28", 30" x 6'8", 20", 24", 26", 28", 30" x 8'0"	<b>1590</b> Pantry 20", 24", 26" x 6'8"	<b>7465</b> 1-3/4" House-to -Garage 1-7/16" RP 28", 30" x 6'8", 28", 30" x 8'0"	<b>465</b> V-Groove 3/4" RP 16", 20", 24", 26", 28", 30" x 6'8", 16", 20", 24", 26", 28", 30" x 8'0"
								
<b>1590 (8'0")</b> Pantry with 3/4" RP 20", 24", 26" x 8'0"	<b>1593</b> Laundry 28", 30" x 6'8"	<b>1593 (8'0")</b> Laundry with 3/4" RP 28", 30" x 8'0"	<b>1310</b> Clear SG 20", 24", 26", 28", 30" x 6'8"	<b>1312 (8'0")</b> Clear SG 20", 24", 26", 28", 30" x 8'0"	<b>1315</b> Clear SG 26", 28", 30" x 6'8"	<b>1318</b> Clear SG 26", 28", 30" x 8'0"	<b>7465</b> 1-3/4" House-to -Garage 1-7/16" RP 28", 30" x 6'8", 28", 30" x 8'0"	<b>465</b> V-Groove 3/4" RP 16", 20", 24", 26", 28", 30" x 6'8", 16", 20", 24", 26", 28", 30" x 8'0"
								
<b>80801 Shaker Full Plank</b> Barn Door w/ V-Groove 30", 36" x 70", 30", 36" x 84"	<b>80812 Shaker Z Pattern</b> Barn Door w/ V-Groove 30", 36" x 70", 30", 36" x 84"	<b>80815 Shaker K Pattern</b> Barn Door w/ V-Groove 30", 36" x 70", 30", 36" x 84"	<b>7465</b> 1-3/4" House-to -Garage, V-Groove 1-7/16" RP 28", 30" x 6'8", 28", 30" x 8'0"	<b>66</b> 3/4" RP 16", 20", 24", 26", 28", 30" x 6'8", 16", 20", 24", 26", 28", 30" x 8'0"	<b>7130</b> 1-3/4" House-to -Garage 1-7/16" RP 28", 30" x 6'8", 28", 30" x 8'0"	<b>80801 Shaker Full Plank</b> Barn Door w/ V-Groove 30", 36" x 70", 30", 36" x 84"	<b>80812 Shaker Z Pattern</b> Barn Door w/ V-Groove 30", 36" x 70", 30", 36" x 84"	<b>80815 Shaker K Pattern</b> Barn Door w/ V-Groove 30", 36" x 70", 30", 36" x 84"

## KNOTTY PINE INTERIOR DOORS

Knotty Pine interior doors are stocked 1-3/8" with panel door designs also stocked 1-3/4" for your house-to-garage application. Stock sizes are also noted.



							
<b>1501</b> Clear SG 20", 24", 26", 28", 30" x 6'8", 20", 24", 26", 28", 30" x 8'0"	<b>1501</b> White Laminate 20", 24", 26", 28", 30" x 6'8", 20", 24", 26", 28", 30" x 8'0"	<b>1590</b> Pantry 20", 24", 26" x 6'8"					
							
<b>82</b> 3/4" RP 16", 20", 24", 26", 28", 30" x 6'8", 16", 20", 24", 26", 28", 30" x 8'0"	<b>7282</b> 1-3/4" House-to -Garage 1-7/16" RP 28", 30" x 6'8", 28", 30" x 8'0"	<b>82</b> V-Groove 3/4" RP 16", 20", 24", 26", 28", 30" x 6'8", 16", 20", 24", 26", 28", 30" x 8'0"	<b>7282</b> 1-3/4" House-to -Garage, V-Groove 1-7/16" RP 28", 30" x 6'8", 28", 30" x 8'0"	<b>465</b> 3/4" RP 16", 20", 24", 26", 28", 30" x 6'8", 16", 20", 24", 26", 28", 30" x 8'0"			
							
<b>7465</b> 1-3/4" House-to -Garage 1-7/16" RP 28", 30" x 6'8", 28", 30" x 8'0"	<b>465</b> V-Groove 3/4" RP 16", 20", 24", 26", 28", 30" x 6'8", 16", 20", 24", 26", 28", 30" x 8'0"	<b>7465</b> 1-3/4" House-to -Garage, V-Groove 1-7/16" RP 28", 30" x 6'8", 28", 30" x 8'0"	<b>66</b> 3/4" RP 16", 20", 24", 26", 28", 30" x 6'8", 16", 20", 24", 26", 28", 30" x 8'0"	<b>7130</b> 1-3/4" House-to -Garage 1-7/16" RP 28", 30" x 6'8", 28", 30" x 8'0"	<b>80801 Shaker Full Plank</b> Barn Door w/ V-Groove 30", 36" x 70", 30", 36" x 84"	<b>80812 Shaker Z Pattern</b> Barn Door w/ V-Groove 30", 36" x 70", 30", 36" x 84"	<b>80815 Shaker K Pattern</b> Barn Door w/ V-Groove 30", 36" x 70", 30", 36" x 84"

SG = SINGLE GLAZED  
FP = FLAT PANEL  
RP = RAISED PANEL



Boise Cascade<sup>®</sup>  
MILLWORK

millwork.bc.com  
3130 N. Longhorn Drive, Suite 100  
Lancaster, Texas 75134  
1-833-757-0138

Simpson<sup>®</sup>  
Door Company





**Boise Cascade**  
MILLWORK

## MOLDED AND FLUSH INTERIOR DOORS

Special Order - S/O

In Stock - •

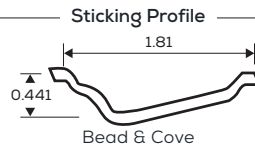

Bead & Cove

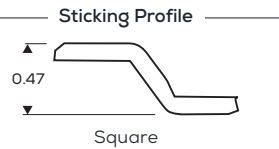

Square

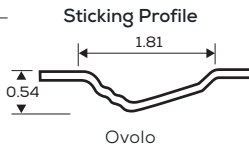

Ovolo

### Molded Hollow Core 6'8" 1-3/8"

Description	1'-0"	1'-3"	1'4"	1'6"	1'8"	2'0"	2'4"	2'6"	2'8"	2'10"	3'0"
Caiman	•	•	•	•	•	•	•	•	•	S/O	•
Carrara	•	•	•	•	•	•	•	•	•	S/O	•
Classique	S/O	S/O	S/O	•	S/O	•	•	•	•	S/O	•
Colonist	•	•	•	•	•	•	•	•	•	•	•
Madison	•	•	•	•	•	•	•	•	•	S/O	•
Monroe	•	•	•	•	•	•	•	•	•	S/O	•
Rockport	•	•	•	•	•	•	•	•	•	S/O	•
Santa Fe	•	•	•	•	•	•	•	•	•	S/O	•

### Molded Hollow Core 8'0" 1-3/8"

Description	1'-0"	1'-3"	1'4"	1'6"	1'8"	2'0"	2'4"	2'6"	2'8"	2'10"	3'0"
Caiman	S/O	S/O	S/O	•	S/O	•	•	•	•	S/O	•
Carrara	S/O	S/O	S/O	•	S/O	•	•	•	•	S/O	•
Colonist	S/O	S/O	S/O	S/O	S/O	S/O	S/O	S/O	S/O	S/O	S/O
Madison	S/O	S/O	S/O	•	S/O	•	•	•	•	S/O	•
Monroe	S/O	S/O	S/O	•	S/O	•	•	•	•	S/O	•
Rockport	S/O	S/O	S/O	•	S/O	•	•	•	•	S/O	•
Santa Fe	S/O	S/O	S/O	•	S/O	•	•	•	•	S/O	•



### Molded Solid Core 6'8" 1-3/8"

Description	1'-0"	1'-3"	1'4"	1'6"	1'8"	2'0"	2'4"	2'6"	2'8"	2'10"	3'0"
Caiman	S/O	S/O	S/O	•	S/O	•	•	•	•	S/O	•
Carrara	S/O	S/O	S/O	•	S/O	•	•	•	•	S/O	•
Classique	S/O	S/O	S/O	S/O	S/O	S/O	S/O	S/O	S/O	S/O	S/O
Colonist	S/O	S/O	S/O	S/O	S/O	S/O	S/O	S/O	S/O	S/O	S/O
Madison	S/O	S/O	S/O	•	S/O	•	•	•	•	S/O	•
Monroe	S/O	S/O	S/O	•	S/O	•	•	•	•	S/O	•
Rockport	S/O	S/O	S/O	•	S/O	•	•	•	•	S/O	•
Santa Fe	S/O	S/O	S/O	•	S/O	•	•	•	•	S/O	•

### Molded Solid Core 6'8" 1-3/4"

Description	1'-0"	1'-3"	1'4"	1'6"	1'8"	2'0"	2'4"	2'6"	2'8"	2'10"	3'0"	20 min	20 min
Caiman	S/O	S/O	S/O	S/O	S/O	S/O	S/O	S/O	S/O	S/O	S/O	•	•
Carrara	S/O	S/O	S/O	S/O	S/O	S/O	S/O	S/O	S/O	S/O	S/O	•	•
Classique	S/O	S/O	S/O	S/O	S/O	S/O	S/O	S/O	S/O	S/O	S/O	•	•
Colonist	S/O	S/O	S/O	S/O	S/O	S/O	S/O	S/O	S/O	S/O	S/O	•	•
Madison	S/O	S/O	S/O	S/O	S/O	•	•	•	•	S/O	•	•	•
Monroe	S/O	S/O	S/O	S/O	S/O	•	•	•	•	S/O	•	•	•
Rockport	S/O	S/O	S/O	S/O	S/O	S/O	S/O	S/O	S/O	S/O	S/O	•	•
Santa Fe	S/O	S/O	S/O	S/O	S/O	S/O	S/O	S/O	S/O	S/O	S/O	•	•

### Molded Solid Core 8'0" 1-3/8"

Description	1'-0"	1'-3"	1'4"	1'6"	1'8"	2'0"	2'4"	2'6"	2'8"	2'10"	3'0"
Caiman	S/O	S/O	S/O	•	S/O	•	•	•	•	S/O	•
Carrara	S/O	S/O	S/O	•	S/O	•	•	•	•	S/O	•
Colonist	S/O	S/O	S/O	S/O	S/O	S/O	S/O	S/O	S/O	S/O	S/O
Madison	S/O	S/O	S/O	•	S/O	•	•	•	•	S/O	•
Monroe	S/O	S/O	S/O	•	S/O	•	•	•	•	S/O	•
Rockport	S/O	S/O	S/O	•	S/O	•	•	•	•	S/O	•
Santa Fe	S/O	S/O	S/O	•	S/O	•	•	•	•	S/O	•

### Molded Solid Core 8'0" 1-3/4"

Description	1'-0"	1'-3"	1'4"	1'6"	1'8"	2'0"	2'4"	2'6"	2'8"	2'10"	3'0"	20 min	20 min
Caiman	S/O	S/O	S/O	•	S/O	•	•	•	•	S/O	•	•	•
Carrara	S/O	S/O	S/O	•	S/O	•	•	•	•	S/O	•	•	•
Colonist	S/O	S/O	S/O	S/O	S/O	S/O	S/O	S/O	S/O	S/O	S/O	S/O	S/O
Madison	S/O	S/O	S/O	•	S/O	•	•	•	•	S/O	•	•	•
Monroe	S/O	S/O	S/O	•	S/O	•	•	•	•	S/O	•	•	•
Rockport	S/O	S/O	S/O	•	S/O	•	•	•	•	S/O	•	•	•
Santa Fe	S/O	S/O	S/O	•	S/O	•	•	•	•	S/O	•	•	•



**Boise Cascade**  
MILLWORK

millwork.bc.com

3130 N. Longhorn Drive, Suite 100  
Lancaster, Texas 75134  
1-833-757-0138





## MOLDED AND FLUSH INTERIOR DOORS

Special Order - S/O  
In Stock - •



Birch



Lauan



Primed Hardboard

### Flush Hollow Core 6'8"

1-3/8"

Description	1'-0"	1'-3"	1'4"	1'6"	1'8"	2'0"	2'4"	2'6"	2'8"	2'10"	3'0"
Birch	S/O	S/O	S/O	•	S/O	•	•	•	•	S/O	•
Lauan	S/O	S/O	S/O	•	S/O	•	•	•	•	S/O	•
Primed Hrdbd	S/O	S/O	S/O	•	S/O	•	•	•	•	S/O	•

### Dunnage Door Slabs 6'8" and 8'0"

1-3/4"

Description	1'-0"	1'-3"	1'4"	1'6"	1'8"	2'0"	2'4"	2'6"	2'8"	2'10"	3'0"
Primed Hrdbd	S/O	S/O	S/O	S/O	S/O	S/O	S/O	S/O	•	S/O	•

### Flush Solid Core 6'8"

1-3/8"

Description	1'-0"	1'-3"	1'4"	1'6"	1'8"	2'0"	2'4"	2'6"	2'8"	2'10"	3'0"
Birch	S/O	S/O	S/O	•	S/O	•	•	•	•	S/O	•
Lauan	S/O	S/O	S/O	S/O	S/O	S/O	S/O	S/O	S/O	S/O	S/O
Primed Hrdbd	S/O	S/O	S/O	•	S/O	•	•	•	•	S/O	•

### Flush Solid Core 8'0"

1-3/8"

Description	1'-0"	1'-3"	1'4"	1'6"	1'8"	2'0"	2'4"	2'6"	2'8"	2'10"	3'0"
Birch	S/O	S/O	S/O	S/O	S/O	S/O	S/O	S/O	S/O	S/O	S/O
Lauan	S/O	S/O	S/O	S/O	S/O	S/O	S/O	S/O	S/O	S/O	S/O
Primed Hrdbd	S/O	S/O	S/O	•	S/O	•	•	•	•	S/O	•

### Flush Solid Core 6'8"

1-3/4"

Description	1'-0"	1'-3"	1'4"	1'6"	1'8"	2'0"	2'4"	2'6"	2'8"	2'10"	3'0"
Birch	S/O	S/O	S/O	S/O	S/O	•	•	•	•	S/O	•
Lauan	S/O	S/O	S/O	S/O	S/O	S/O	S/O	S/O	•	S/O	•
Primed Hrdbd	S/O	S/O	S/O	S/O	S/O	•	•	•	•	S/O	•

### Flush Solid Core 8'0"

1-3/4"

Description	1'-0"	1'-3"	1'4"	1'6"	1'8"	2'0"	2'4"	2'6"	2'8"	2'10"	3'0"
Birch	S/O	S/O	S/O	S/O	S/O	S/O	S/O	S/O	S/O	S/O	S/O
Lauan	S/O	S/O	S/O	S/O	S/O	S/O	S/O	S/O	S/O	S/O	S/O
Primed Hrdbd	S/O	S/O	S/O	•	S/O	•	•	•	•	S/O	•

Stock status is subject to availability, please contact your Boise Cascade Millwork Representative with any questions.





## MARWIN ATTIC STAIRS

Item	Size	Description	Extended Description
0804100	22-1/2X54X8-9	A80 ATLAS STAIR 250 LB. DUTY RATING	A80
0804105	22-1/2X54X10	A81 ATLAS STAIR 250 LB. DUTY RATING	A81
0804110	25-1/2X54X8-9	A100 ATLAS STAIR 250 LB. DUTY RATING	A100
0804115	25-1/2X54X10	A101 ATLAS STAIR 250 LB. DUTY RATING	A101
0804170	25-1/2X54X8-9	A100FT ATLAS STAIR FIRETREATED	A100FT
0804175	25-1/2X54X10	A101FT ATLAS STAIR FIRETREATED	A101FT
0804190	25-1/2X54X8-9	S100 SUPERIOR STAIR 300 LB.DUTY RATING	S100
0804195	25-1/2X54X10	S101 SUPERIOR STAIR 300 LB.DUTY RATING	S101
0804212	25-1/2X54X10'4"	TITAN ALUM 375 DUTY FIRE TREATED	T-101FT
0804220	25-1/2X63X12	T2512FT TITAN ALUM STAIR FIRETREATED DR	T2512FT
0804240	25-1/2X54X10	S101FT SUPERIOR STAIR 300LB FIRE RATED	S101FT



## MARWIN POCKET DOOR FRAMES

Item	Size	Description	Extended Description
769000550	4-5/8X8/0	CLEAR PINE JAMBS ONLY FOR POCKET FRAMES	JAMBIX6
7712085		200LB BB 3 WHEEL POCKET DOOR HDW BAG	PDJ200BB
7712090		POCKET DOOR CONVERGING KIT 15555PPK3	PDFCKITJ
7712123		POCKET DOOR FRAME SOFT CLOSE HARDWARE	PD200SC
7712525	2068	W/T ALUM TRACK 200# BB HDWE FJ-JAMB	2/0 x 6/8 BUILT UP PDF 4-5/8"
7712526	2468	W/T ALUM TRACK 200# BB HDWE FJ-JAMB	2/4 x 6/8 BUILT UP PDF 4-5/8"
7712527	2668	W/T ALUM TRACK 200# BB HDWE FJ-JAMB	2/6 x 6/8 BUILT UP PDF 4-5/8"
7712528	2868	W/T ALUM TRACK 200# BB HDWE FJ-JAMB	2/8 x 6/8 BUILT UP PDF 4-5/8"
7712529	3068	W/T ALUM TRACK 200# BB HDWE FJ-JAMB	3/0 x 6/8 BUILT UP PDF 4-5/8"
7712530	2080	W/T ALUM TRACK 200# BB HDWE FJ-JAMB	2/0 x 8/0 BUILT UP PDF 4-5/8"
7712531	2480	W/T ALUM TRACK 200# BB HDWE FJ-JAMB	2/4 x 8/0 BUILT UP PDF 4-5/8"
7712532	2680	W/T ALUM TRACK 200# BB HDWE FJ-JAMB	2/6 x 8/0 BUILT UP PDF 4-5/8"
7712533	2880	W/T ALUM TRACK 200# BB HDWE FJ-JAMB	2/8 x 8/0 BUILT UP PDF 4-5/8"
7712534	3080	W/T ALUM TRACK 200# BB HDWE FJ-JAMB	3/0 x 8/0 BUILT UP PDF 4-5/8"
7712580	2068	ALUM TRACK 200# BB HDWE A-JAMB	2/0 x 6/8 BUILT UP PDF 6-5/8"
7712581	2468	ALUM TRACK 200# BB HDWE A-JAMB	2/4 x 6/8 BUILT UP PDF 6-5/8"
7712582	2668	ALUM TRACK 200# BB HDWE A-JAMB	2/6 x 6/8 BUILT UP PDF 6-5/8"
7712583	2868	ALUM TRACK 200# BB HDWE A-JAMB	2/8 x 6/8 BUILT UP PDF 6-5/8"
7712584	3068	ALUM TRACK 200# BB HDWE A-JAMB	3/0 x 6/8 BUILT UP PDF 6-5/8"
7712585	2080	ALUM TRACK 200# BB HDW A-JAMB	2/0 x 8/0 BUILT UP PDF 6-5/8"
7712586	2480	ALUM TRACK 200# BB HDW A-JAMB	2/4 x 8/0 BUILT UP PDF 6-5/8"
7712587	2680	ALUM TRACK 200# BB HDW A-JAMB	2/6 x 8/0 BUILT UP PDF 6-5/8"
7712588	2880	ALUM TRACK 200# BB HDW A-JAMB	2/8 x 8/0 BUILT UP PDF 6-5/8"
7712589	3080	ALUM TRACK 200# BB HDW A-JAMB	3/0 x 8/0 BUILT UP PDF 6-5/8"
809388654	4-5/8X4/0	CONTINUOUS POCKET DOOR HEADER 4-5/8" W/T	40CTHD200WTNH45
809388655	4-5/8X5/0	CONTINUOUS POCKET DOOR HEADER 4-5/8" W/T	50CTHD200WTNH45
809388656	4-5/8X6/0	CONTINUOUS POCKET DOOR HEADER 4-5/8" W/T	60CTHD200WTNH45





# JAMBS

Non-Stock - N/S

In Stock - •

## Exterior Jambs

Description	Primed	Duraframe	Hemlock	Okume	Kalder
4-9/16"-6'8"	•	•	•	•	•
4-9/16"-8'0"	•	•	•	•	•
4-9/16"-2'8"	•	N/S	N/S	N/S	N/S
4-9/16"-3'0"	•	N/S	•	•	•
4-9/16"-6'0"	•	N/S	N/S	N/S	N/S
4-9/16"-14'0"	•	N/S	N/S	N/S	N/S
5-1/4"-6'8"	N/S	N/S	•	•	N/S
5-1/4"-3'0"	N/S	N/S	N/S	•	N/S
5-1/4"-8'0"	N/S	N/S	•	•	N/S
6-9/16"-6'8"	•	•	•	•	•
6-9/16"-8'0"	•	•	•	•	•
6-9/16"-2'8"	•	N/S	N/S	N/S	N/S
6-9/16"-3'0"	•	N/S	•	•	•
6-9/16"-6'0"	•	N/S	N/S	N/S	N/S
6-9/16"-14'0"	•	N/S	N/S	N/S	N/S
7-1/4"-6'8"	N/S	N/S	•	•	N/S
7-1/4"-8'0"	N/S	N/S	•	•	N/S
7-1/4"-3'-0"	N/S	N/S	•	•	N/S
11-1/4"-6'8"	N/S	•	N/S	N/S	N/S
11-1/4"-8'0"	N/S	•	N/S	N/S	N/S
Mullpost 3-9/16" 6'8"	N/S	•	N/S	N/S	N/S
Mullpost 3-9/16" 6'8" Hinge RH/LH	N/S	•	N/S	N/S	N/S
Mullpost 3-9/16" 6'8" Strike RH/LH	N/S	•	N/S	N/S	N/S
Mullpost 3-9/16" 8'0"	N/S	•	N/S	N/S	N/S
Mullpost 4-9/16" 6'8" Fatboy	N/S	•	N/S	N/S	N/S
Mullpost 4-9/16" 8'0" Fatboy	N/S	•	N/S	N/S	N/S
Mullpost 4-3/8" 6'8" Patio	N/S	•	N/S	N/S	N/S
Mullpost 4-3/8" 8'0" Patio	N/S	•	N/S	N/S	N/S
Mullpost 4-3/8" 6'8" Strike RH/LH	N/S	•	N/S	N/S	N/S
Mullpost 4-3/8"x2" 6'6" Retro	N/S	•	N/S	N/S	N/S
Mullpost 4-3/8"x2" 6'8" OS Patio	N/S	•	N/S	N/S	N/S
Mullpost 4-3/8"x2" 8'0" OS Patio	N/S	•	N/S	N/S	N/S
Mullpost 4-3/8"x2" 6'8" IS Patio	N/S	•	N/S	N/S	N/S
Mullpost 4-3/8"x2" 8'0" IS Patio	N/S	•	N/S	N/S	N/S
Mullpost 4-3/8" x 2-1/2"-8'0"	N/S	N/S	•	N/S	N/S
Mullpost 4-3/8" x 2-1/2"-9'0"	N/S	N/S	•	N/S	•
T-Astragal 1-3/8 (1-1/4"x2")100"	N/S	N/S	N/S	N/S	•



## Exterior Jambs (CONT.)

Description	Primed	Duraframe	Hemlock	Okume	Kalder
T-Astragal 1-3/4 (1-1/4"x2-1/2")100"	N/S	N/S	N/S	N/S	•
T-Astragal 1-3/4 Ext.(1-1/4"x3-1/8")98"	N/S	N/S	•	•	•
WM180 Bmould 17"	•	N/S	N/S	N/S	N/S
WM180 Bmould 6'8"	•	•	N/S	N/S	N/S
WM180 Bmould 8'0"	•	•	•	•	N/S
WM180 Bmould 10'0"	N/S	N/S	N/S	N/S	•
WM180 Bmould 2'8"	•	N/S	N/S	N/S	N/S
WM180 Bmould 3'0"	•	N/S	N/S	N/S	N/S
S4S 1 1/16" X 3-1/2 -9'	N/S	N/S	•	•	N/S
S4S 1 1/16" X 3-1/2 -10'	N/S	N/S	N/S	N/S	•
S4S 1 1/16" X 5-1/2 -10'	N/S	N/S	N/S	N/S	•
S4S 1 1/16" X 7-1/4 -10'	N/S	N/S	N/S	N/S	•

## Interior Jambs

Description	Fingerjoint	Primed	Solid	Veneer
4-9/16"-6'8"	•	•	•	•
4-9/16"-8'0"	•	•	•	•
4-9/16"-3'0"	•	N/S	•	N/S
4-9/16"-6'0"	•	N/S	•	N/S
4-7/8"-6'8"	•	N/S	N/S	N/S
4-7/8"-8'0"	•	N/S	N/S	N/S
4-7/8"-3'0"	•	N/S	N/S	N/S
4-7/8"-6'0"	•	N/S	N/S	N/S
5-1/8"-6'8"	N/S	N/S	•	N/S
5-1/8"-6'0"	N/S	N/S	•	N/S
5-1/8"-3'0"	N/S	N/S	•	N/S
6-9/16"-6'8"	•	N/S	•	N/S
6-9/16"-8'0"	•	N/S	•	N/S
6-9/16"-3'0"	•	N/S	•	N/S
6-9/16"-6'0"	•	N/S	•	N/S

Description	Knotty Alder
4-9/16"-6'8"	•
4-9/16"-8'0"	•
4-9/16"-3'0"	•
5-1/4"-6'8"	•
5-1/4"-8'0"	•
5-1/4"-3'0"	•
6-9/16"-6'8"	•
6-9/16"-8'0"	•
6-9/16"-3-0"	•
Mullpost 4-3/8" x 2-3/8" -9'	•



Standard Flat Jamb with Applied Stop



Rabbet Jamb



Flat Jamb

Stock status is subject to availability, please contact your Boise Cascade Millwork Representative with any questions.





**Boise Cascade**  
MILLWORK

## CASINGS

Non-Stock - N/S  
In Stock - •

Description	Fingerjoint	Primed	Solid
WM324 Wedge Casing 5/8" x 2-1/8" 14'	•	N/S	N/S
A-Colonial Casing 5/8" x 2-1/4"-7'	•	N/S	N/S
A-Colonial Casing 5/8" x 2-1/4"- 8'7"(103")	•	N/S	•
A-Colonial Casing 5/8" x 2-1/4" 14'	•	N/S	N/S
WM356 Casing 5/8" x 2-1/4"-7'	•	N/S	N/S
A-Colonial Casing 5/8" x 2-1/2"-7'	•	N/S	N/S
A-Colonial Casing 5/8" x 2-1/2"-8'7"(103")	•	N/S	•
C-195 Casing 9/16" x 2-1/2"-8'7"(103")	•	N/S	•
C-211 Casing 5/8" x 2-1/2"-8'3"(103")	•	N/S	•
C-211 Casing 5/8" x 2-1/2"-14'	•	N/S	N/S
C-322 Casing 5/8" x 2-1/2"-7'	•	N/S	N/S
C-322 Casing 5/8" x 2-1/2"-8'7"(103")	•	N/S	•
#9 B Base 1/2" x 3-1/4" 8'7"(103")	•	N/S	•
MC9E Casing 7/8" x 3-1/4" 8'6"(103")	N/S	•	N/S
C-295 Casing 9/16" x 3-1/2"-8'7"(103")	•	N/S	•
LC11 Casing 5/8" x 3-1/2" 8'7"(103")	•	N/S	•
C-522 casing 5/8" x 3-1/2" 8'7"(103")	•	N/S	•
C347 Casing 9/16" x 3-7/16" 16'	•	N/S	N/S
A-Colonial Casing 5/8" x 3-1/2" 8'7"(103")	•	N/S	•
WM876 Door Stop 7/16" x 1-3/8"	•	N/S	•
1X4 S4S 8'6"(102")	N/S	•	•

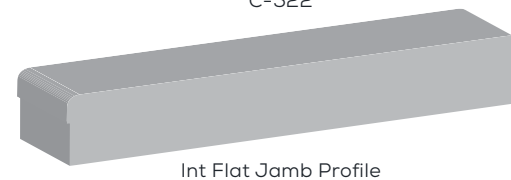
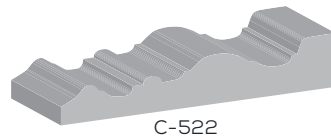
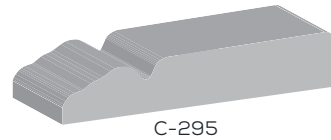
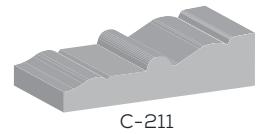
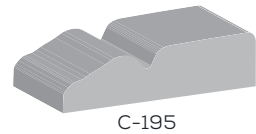
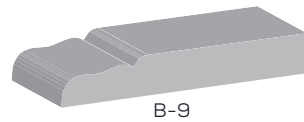
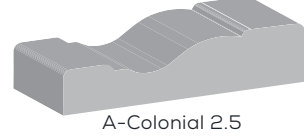
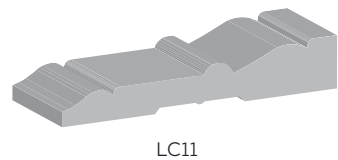
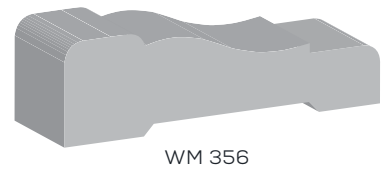

## PENROD BARN DOOR HARDWARE

Item	Length	Description
769059001	6'	BARN DOOR BENT STRAP SET FLAT BLACK
769059003	8'	BARN DOOR BENT STRAP SET FLAT BLACK
769059005	6'	BARN DOOR BENT STRAP SET SATIN NICKEL
769059007	8'	BARN DOOR BENT STRAP SET SATIN NICKEL
769059060		BARN DOOR CON PLATE FLAT BLACK
769059084		BARN DOOR SOFT CLOSE KIT FLAT BLACK



## KWIKSET

Item	Description
653000607	58 SQT 11P SMT RCAL 5063
653002638	660 15 SMT RCAL RCS
653002639	660 11P SMT RCAL RCS K3
653003135	780 15 SMT RCAL 5063
653003136	780 11P SMT RCAL 5063
653003137	158 SQT 15 SMT RCAL 5063
653008704	913CNT 15 SMT RCALFD
653008705	913CNT 11P SMT RCALFD
653008708	913TRL 15 SMT RCALFD
653008709	913TRL 11P SMT RCALFD
653009503	85063- 11P
653009504	85063-15
653040500	604BL 15 LH
653040501	604BL 15 RH
653040502	604BL 11P LH
653040503	604BL 11P RH
653041433	400CV 11P SMT 6AL RCS K3
653041434	400CV 15 SMT 6AL RCS
653041474	604CV 15
653041483	604CV 11P V1

Item	Description
653042402	740H 15 SMT 6AL RCS K3
653042404	966H 15
653042410	966H 11P
653042411	740H 11P SMT 6AL RCS
653060500	405BL 15 SMT 6AL RCS K4
653060501	405BL 11P SMT 6AL RCS K4
653062453	156HFL SQT 11P SMT 6AL RCS
653062454	156HFL SQT 15 SMT 6AL RCS
653062493	966HFL SQT 11P
653062494	966HFL SQT 15
653080005	687AMD LIP 15 SMT RCAL RCS
653080006	687AMD LIP 11P SMT RCAL RCS
653081315	687DA LIP 15 SMT RCAL RCS
653081316	687DA LIP 11P SMT RCAL RCS
653082100	971HFL SQT 15
653082104	971HFL SQT 11P
653082404	800HE LIP 15 SMT RCAL 5063
653082405	800HE LIP 11P SMT RCAL 5063
653086006	818SCE LIP 15 SMT RCAL RCS
53086007	818SCE LIP 11P SMT RCAL RCS



**Boise Cascade**  
MILLWORK

[millwork.bc.com](http://millwork.bc.com)  
3130 N. Longhorn Drive, Suite 100  
Lancaster, Texas 75134  
1-833-757-0138

**Kwikset**

# KITCHEN KOMPACT CABINETRY

Fully Assembled • Immediate Delivery • Made in USA



- Joined by mortise & tenon
- Solid wood hanging rails
- 3/4" solid wood face frames
- Shelves are dadoed into sides



**White** KITCHEN KOMPACT  
BY KITCHEN KOMPACT



## WALL Cabinets

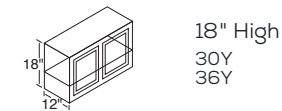
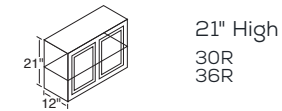
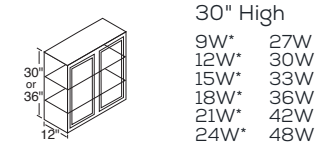
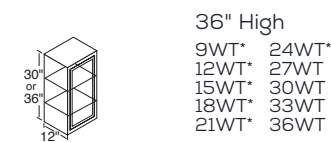

## WALL CORNER Cabinets

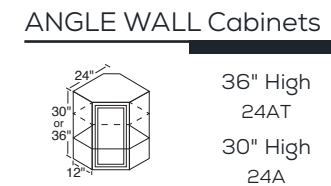
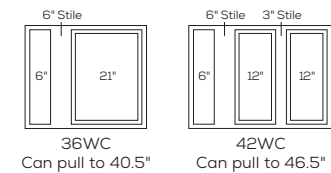
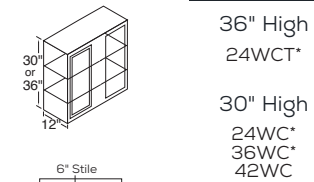

## BASE Cabinets

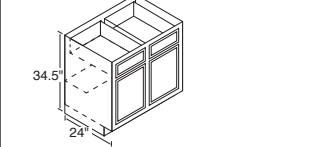
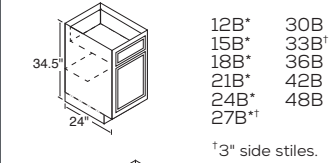

## TRAY Cabinets

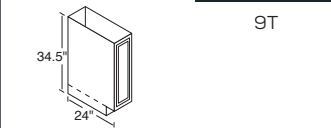

## DRAWER Cabinets

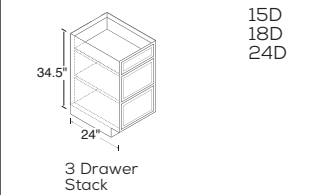

## BASE CORNER Cabinets

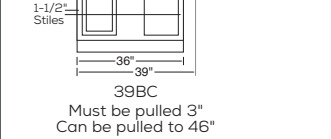
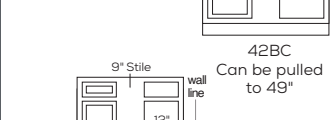
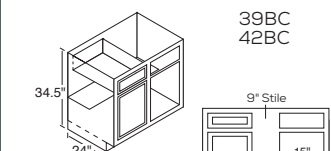

## RANGE & SINK BASE Cabinets

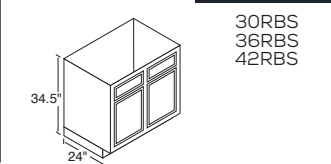

## LAZY SUSAN CORNER Cabinet

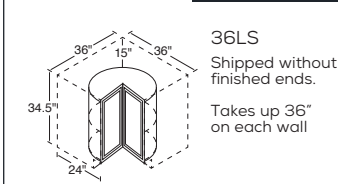

## BROOM Cabinets

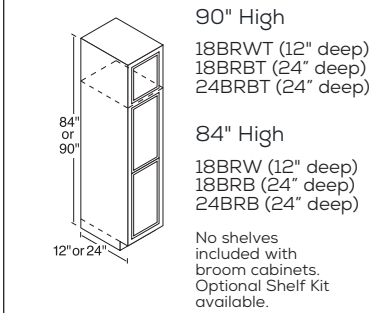

## ACCESSORIES & MOULDINGS

- 3" Filler Strip
- 6" Filler Strip
- End Panel Faced .5" x 24" x 34.5"
- Refrigerator End Panel Faced .5" x 24" x 90"
- Matching Toe Kick
- 72" Valance
- Scribe
- Quarter Round
- Large Crown
- Small Crown
- Back Panel 34.5" x 48" x 3/16"
- 15" Base Roll-Out Tray
- 18" Base Roll-Out Tray
- 24" Base Roll-Out Tray



## VANITY Cabinets

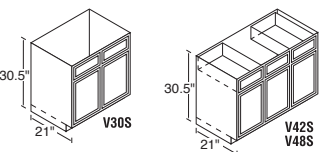
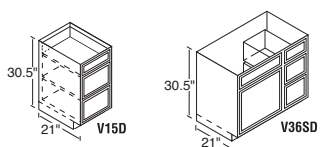
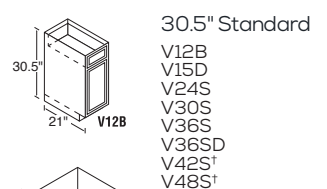

## TALL VANITY Cabinets

Tall vanities are only available for Glenwood, Warmwood and DWhite.

All standard and tall vanities 21" Deep

## 34.5" Standard

V12BT V36SDT  
V15DT V42ST  
V24ST V48ST  
V36ST

\*Two outside working drawers.

## ADA ACCESSIBLE Cabinets

ADA accessible cabinets are available, on special order, in a limited number of sizes. Cabinet Code Descriptions For ease of ordering, the numerical designation indicates the cabinet width, the letter identifies the height. \*Single door.



millwork.bc.com  
3130 N. Longhorn Drive, Suite 100  
Lancaster, Texas 75134  
1-833-757-0138

Stock status is subject to availability, please contact your Boise Cascade Millwork Representative with any questions.