



Boise Cascade®
MILLWORK



Boise Cascade®
MILLWORK

DENVER MILLWORK



millwork.bc.com

11011 E 104th Ave, Suite 1000

Commerce City, CO 80640

720-653-3333

DenverMillwork@bc.com

STOCK CATALOG



WHY BOISE CASCADE MILLWORK?

Boise Cascade® Millwork is a division of Boise Cascade, one of the nation's largest manufacturers and distributors of building materials for the residential and commercial construction industry. For more than 60 years, Boise Cascade has served homebuilders, contractors, developers, and homeowners – and now we're bringing that expertise to millwork. With locations in some of the country's fastest growing markets, Boise Cascade Millwork offers top-of-the-line exterior and interior door solutions and components. If you can imagine it, we can get it or create it. At Boise Cascade Millwork we take pride in meeting the demands of our customers. Only Boise Cascade Millwork can leverage the buying power and reach of Boise Cascade Building Materials Distribution to get the best value and the toughest-to-access inventory. We understand that it's more than a just a door, it's a partnership you can count on with the brands your customers can rely on.



Boise Cascade®
MILLWORK



TABLE OF CONTENTS

PAGE

PrismaGuard® Prefinish	1
PrismaGuard® Premium Paint	2
Therma-Tru Doors	
Classic Craft Mahogany Common Arch	3
Classic Craft®	4-7
Fiber-Classic® Oak	8
Fiber-Classic® Mahogany/Oak	9
Smooth-Star®	10-13
Steel-Profiles™/Traditions	14
Advanta Lite Frame	15
Glass	
Calix	16
Echelon	16
Kensington	17
Wellesley	18
Latitude	19
Homeward™	20
Texas Star	21
Augustine®	22
Borrassa®	23
Lucerna®	23
Saratoga™	24
Riserva®	25
Pembroke™	25
Axis®	26
Internal Blinds	27
Reeded	28
Satin Etch	29
Chord	30
Chinchilla	31
Rainglass	32
Granite	33
Divided Lites	34
Clear Glass	35
Grilles	36
Frames	37
Fasteners Setting Tool & Screw Plug Covers	37
Composite Entry Mullion	38
Composite Patio Mullion	38
Cove Mould	38
Brickmould	38
Sills	39-41
Door Bottoms	42
Astragals	43
Endrail	43
Weatherstrip	44
Exterior Hinges	45-46
Interior Hinges	47-48
Handlesets	49-50
Hardware	51
Door & Lite Divider Bars	51
Dentil Shelves	52
Simpson Doors	
Douglas Fir Exterior	53
Knotty Alder Exterior	54
Redi-Prime® Interior	55
Douglas Fir Interior	56
Knotty Alder Interior	57-58
Pine Interior	59
Knotty Pine Interior	60
Steve's	
Molded and Flush Interior Doors	61-64
Exterior Frames & Jambs	65-66
Mouldings	67
Bard Door Hardware	67
Kwikset	68
DURA-TECH™	69-70
Eclisse Pocket Door Frames	71
On Site Door Shop Services	72



Boise Cascade®
MILLWORK

PRISMAGUARD PREFINISH

Handcrafted and professionally applied in a controlled environment, low-maintenance PrismaGuard® finish preserves your door's lasting beauty and protects against normal wear and tear, saving you time and money. And it's backed by a 10-year limited finish warranty for your peace of mind.

PrismaGuard® Stain Options

Stains are shown on Classic Craft Mahogany Grain



PrismaGuard® Brushed Finish Options

Available for select Smooth-Star door styles



Note: Finish colors may vary from an actual application due to fluctuations in finishing or printing.



Durable Topcoat

Professional Application

PRISMAGUARD PREMIUM PAINT

Add a pop of color and tailor the look of the entry. PrismaGuard premium paint is designed with high-definition color and optimal sheen to enhance the look of smooth and wood-grained Therma-Tru® products for a beautiful lasting impression.

PrismaGuard® Paint Options



Boise Cascade®
MILLWORK

SYMPHONY COLLECTION™

Introducing the Symphony Collection by Boise Cascade

Enhance your home with this palette offering a ten year PrismaGuard warranty.



Note: Finish colors may vary from an actual application due to fluctuations in finishing or printing. See your Therma-Tru seller for details on the PrismaGuard limited warranty and exclusions. All trademarks are property of their respective owners.



Boise Cascade®
MILLWORK

millwork.bc.com

11011 E 104th Ave, Suite 1000
Commerce City, CO 80640
720-653-3333
DenverMillwork@bc.com

THERMA-TRU® DOORS



Boise Cascade[®]
MILLWORK

CLASSIC CRAFT MAHOGANY COMMON ARCH^{††}



CLASSIC CRAFT[®]

Designed to echo the grain of the largest species of American Hemlocks – the Western Hemlock tree – found in lush coastal rainforests of the Pacific Northwest.



Boise Cascade[®]
MILLWORK

millwork.bc.com
11011 E 104th Ave, Suite 1000
Commerce City, CO 80640
720-653-3333
DenverMillwork@bc.com

Stock status is subject to availability, please contact your Boise Cascade Millwork Representative with any questions.

^{††} = QUICK SHIP
SDLF6 = SIMULATED DIVIDED LITES

SDL = SIMULATED DIVIDED LITES
SDLF3 = SIMULATED DIVIDED LITES

THERMA TRU[®]
DOORS

thermatru.com | 1-800-THERMA-TRU | 4



Boise Cascade
MILLWORK

CLASSIC CRAFT® (CONTINUED)

Classic Craft® doors offer the authentic look of wood. It's virtually impossible to tell the difference. Performing as exceptionally as they look, offering long-lasting energy efficiency, durability and security.



CCA211-1D††
Homeward Glass
3'0" x 6'8"



CCA8211-1D††
Homeward Glass
3'0" x 8'0"



CCA210-LE
Low-E Glass
3'0" x 6'8"

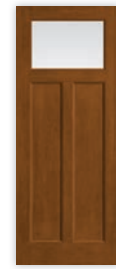

CCA8210-LE
Low-E Glass
3'0" x 8'0"



CCA220-SDLLE
Low-E Glass
3'0" x 6'8"



CCA8220-SDLLE
Low-E Glass
3'0" x 8'0"



CCA1100
3'0" x 6'8"



CCA81100
3'0" x 8'0"



CCA4905-DDBF3
3'0" x 6'8"



CCA84905-DDBF3
3'0" x 8'0"



CCA4915L-DDBF3
3'0" x 6'8"



CCA84915L-DDBF3
3'0" x 8'0"



CCA230-SDLLE
Low-E Glass
3'0" x 6'8"



CCA8230-SDLLE
Low-E Glass
3'0" x 8'0"



CCA240-SDLLE
Low-E Glass
3'0" x 6'8"

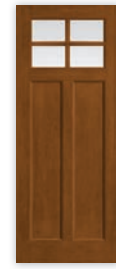

CCA8240-SDLLE
Low-E Glass
3'0" x 8'0"



CCA260-SDLLE
Low-E Glass
3'0" x 6'8"



CCA8260-SDLLE
Low-E Glass
3'0" x 8'0"



CCA4915R-DDBF3
3'0" x 6'8"



CCA84915R-DDBF3
3'0" x 8'0"

Available in Full Light:

Low-E



Satin Etch



CCA87100-LE
Low-E Glass
3'6" x 8'0"



CCA87200-SDLLE
Low-E Glass
3'6" x 8'0"



CCA87300-SDLLE
Low-E Glass
3'6" x 8'0"



CCA87400-SDLLE
Low-E Glass
3'6" x 8'0"



CCA87600-SDLLE
Low-E Glass
3'6" x 8'0"

Other Available Glass Options:

Granite



Chinchilla



Rainglass



Chord



1D = BLACK NICKEL CAMING
1C = BRUSHED NICKEL CAMING
SDL = SIMULATED DIVIDED LITES
SDLF3 = SIMULATED DIVIDED LITES
DDBF3 = DOOR DIVIDER BARS

†† = QUICK SHIP



Boise Cascade
MILLWORK

millwork.bc.com
11011 E 104th Ave, Suite 1000
Commerce City, CO 80640
720-653-3333
DenverMillwork@bc.com

THERMA TRU
DOORS

thermatru.com | 1-800-THERMA-TRU |



Boise Cascade
MILLWORK

CLASSIC CRAFT® (CONTINUED)

Choose from our many door selections to complement the architectural style of the home. Choose from premium fiberglass entryways in four wood grains or a smooth paintable surface that all rival custom wood.

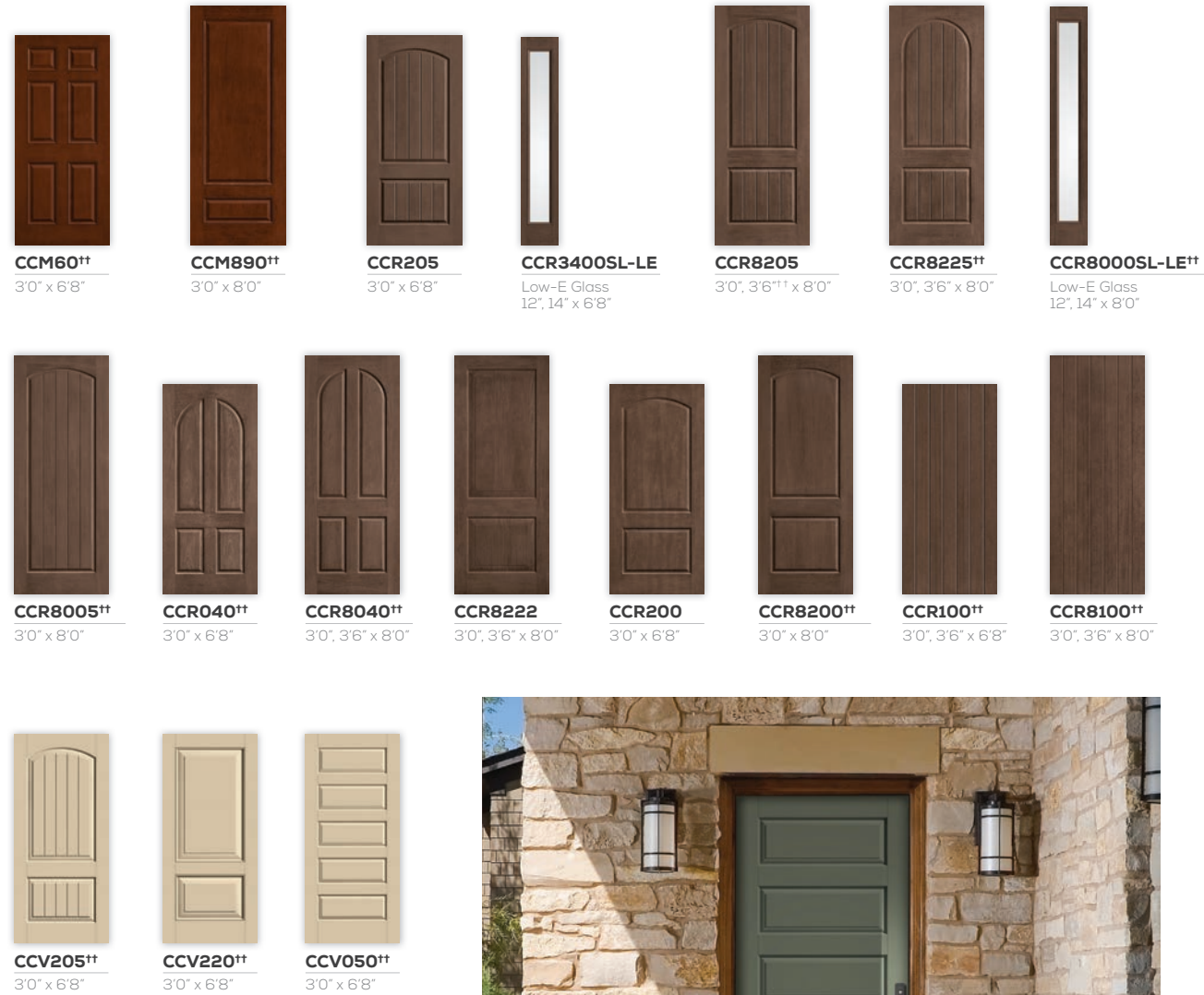

FIBER-CLASSIC® OAK

Create an airy, open feeling in the home with larger daylight openings. EnLiten flush-glazed designs provide a simple profile with no added embellishments around the glass.



† = TWO WEEK LEAD
** = QUICK SHIP



Boise Cascade
MILLWORK

millwork.bc.com
11011 E 104th Ave, Suite 1000
Commerce City, CO 80640
720-653-3333
DenverMillwork@bc.com

THERMA TRU
DOORS



Boise Cascade
MILLWORK

FIBER-CLASSIC® MAHOGANY / OAK

Fiber-Classic Mahogany complements rich wood tones in home exteriors, extending the look to the outside with beauty and elegance. Fiber-Classic Oak features the warm look and feel of natural Oak graining.

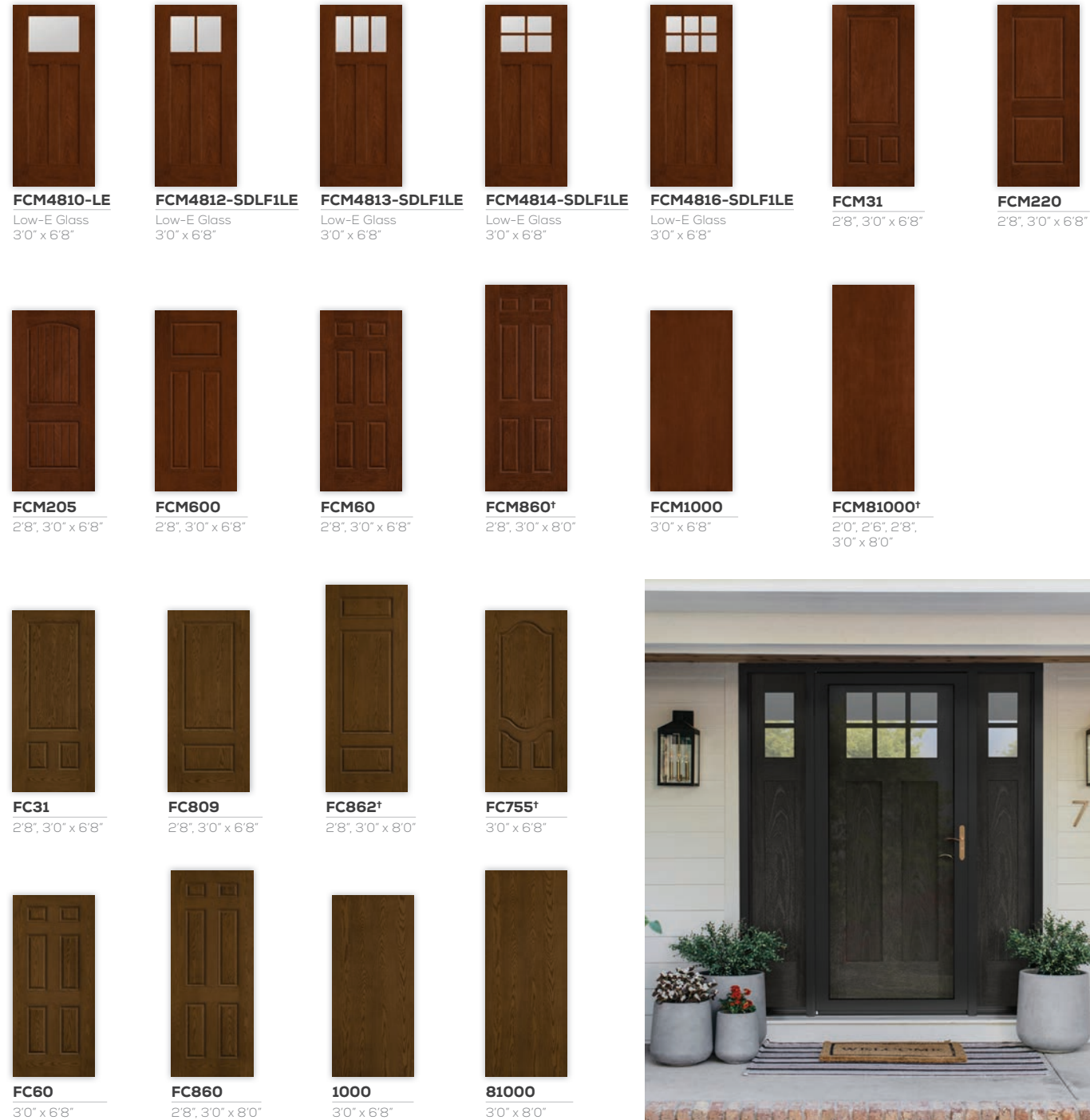

SMOOTH-STAR®

Smooth-Star fiberglass doors are ready-to-paint with crisp, clean contours making them the more attractive and durable alternative to steel.

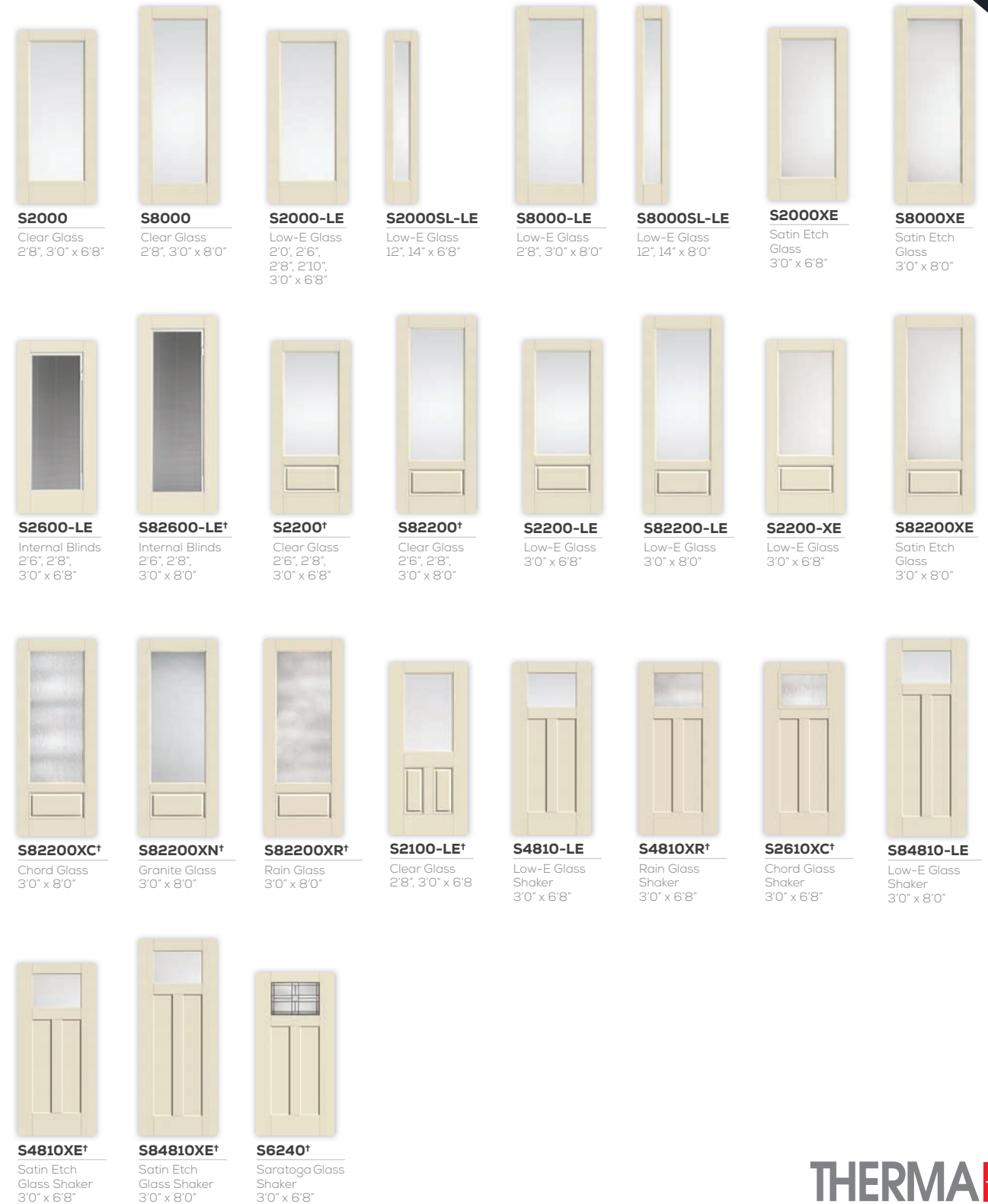

† = TWO WEEK LEAD



Boise Cascade
MILLWORK

millwork.bc.com
11011 E 104th Ave, Suite 1000
Commerce City, CO 80640
720-653-3333
DenverMillwork@bc.com

Stock status is subject to availability, please contact your Boise Cascade Millwork Representative with any questions.

THERMA TRU
DOORS



Boise Cascade
MILLWORK

SMOOTH-STAR®

Smooth-Star fiberglass doors are ready-to-paint with crisp, clean contours making them the more attractive and durable alternative to steel.

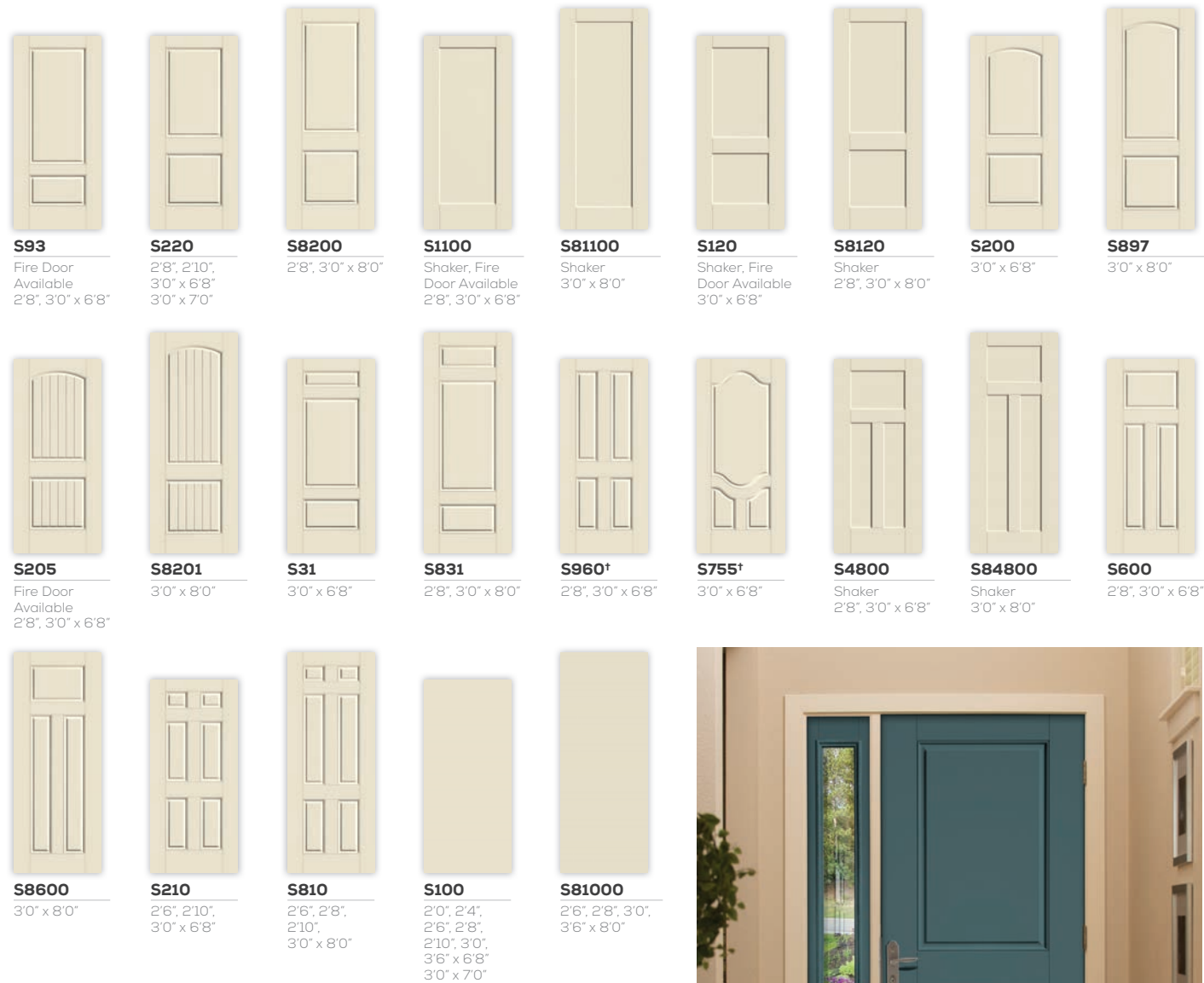

SMOOTH-STAR®

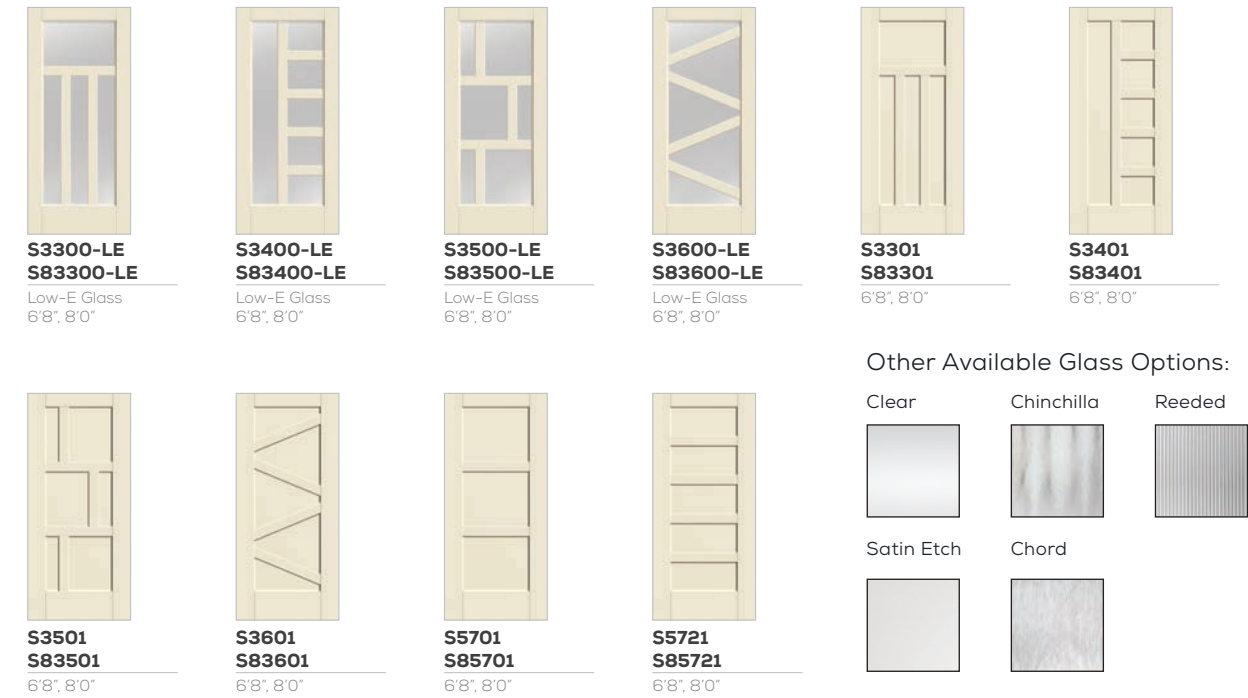

† = TWO WEEK LEAD



Boise Cascade
MILLWORK

millwork.bc.com
11011 E 104th Ave, Suite 1000
Commerce City, CO 80640
720-653-3333
DenverMillwork@bc.com

THERMA TRU
DOORS

thermatru.com | 1-800-THERMA-TRU | 12



Boise Cascade
MILLWORK

SMOOTH-STAR® 1/2 LITES†



Other Available Glass Options:

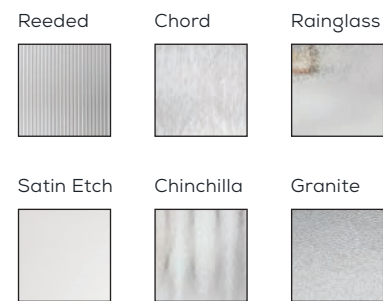

STEEL – PROFILES™ / TRADITIONS

Coupling distinctive styling with affordability, Therma-Tru steel doors offer versatile front entry and house-to-garage options.



Stock status is subject to availability, please contact your Boise Cascade Millwork Representative with any questions.

† = TWO WEEK LEAD TIME



Boise Cascade
MILLWORK

millwork.bc.com
11011 E 104th Ave, Suite 1000
Commerce City, CO 80640
720-653-3333
DenverMillwork@bc.com

THERMA-TRU
DOORS

thermatru.com | 1-800-THERMA-TRU | 14



Boise Cascade®
MILLWORK

ADVANTA LITE FRAME

A new frame of mind. Achieve a seamless look with the Advanta™ lite frame, an innovative, patented solution from Therma-Tru. Avoid the unsightly look of missing screw plugs and enhance the beauty of your home's entryway.



CALIX

Glass Privacy Rating 1 10

Calix includes an on-trend "x" design and a delicate diamond pattern with 1 clear glass, providing fine-lined geometric appeal.

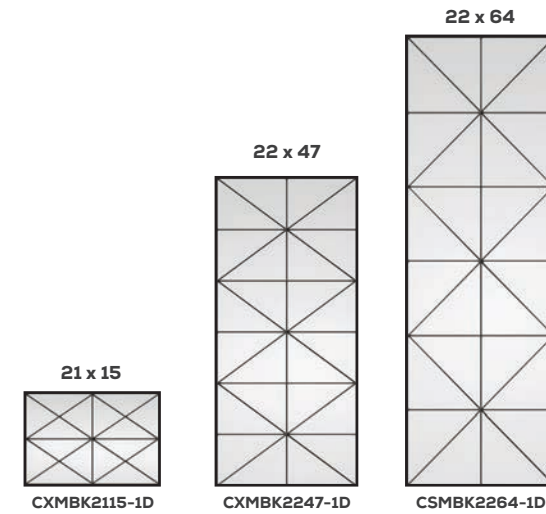

ECHELON

Glass Privacy Rating 1 10

Echelon provides 1 clear glass accented with eased angles and clean edges infused with elements of diamonds and triangles.

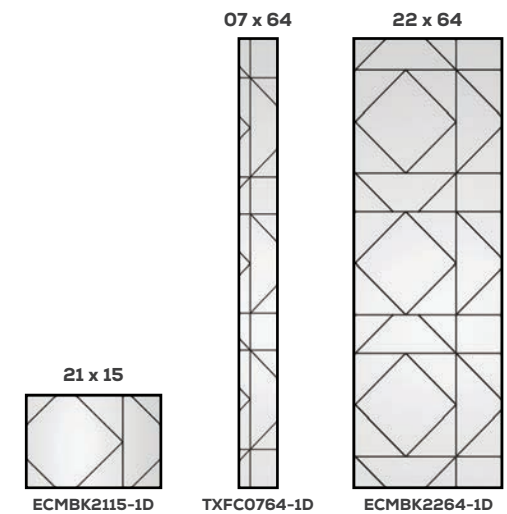

Boise Cascade®
MILLWORK

millwork.bc.com
11011 E 104th Ave, Suite 1000
Commerce City, CO 80640
720-653-3333
DenverMillwork@bc.com

THERMA TRU®
DOORS



Boise Cascade®
MILLWORK

KENSINGTON

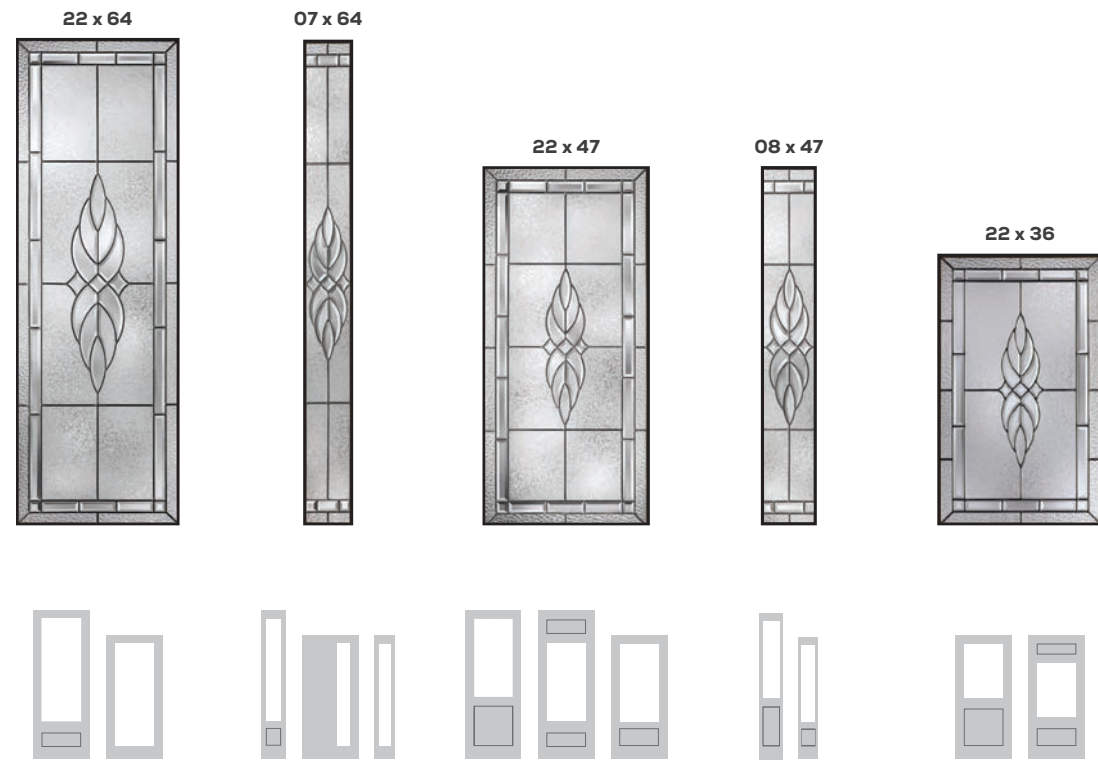

WELLESLEY

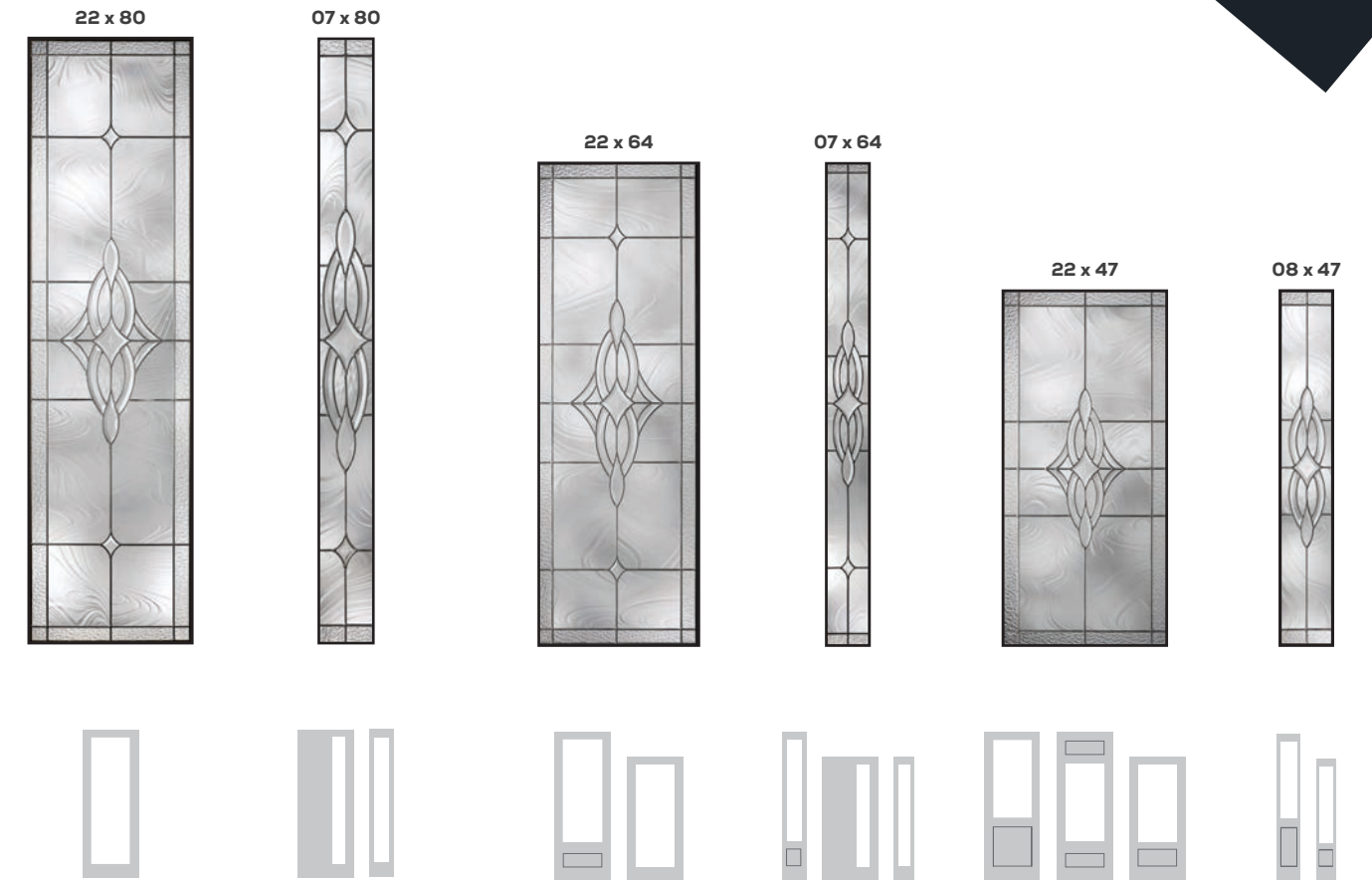

Boise Cascade®
MILLWORK

millwork.bc.com
11011 E 104th Ave, Suite 1000
Commerce City, CO 80640
720-653-3333
DenverMillwork@bc.com



Boise Cascade[®]
MILLWORK

LATITUDE

Glass Privacy Rating 1 **2** 10

Bending tradition. Latitude showcases 1 seeded glass and simple curved details in a half-moon geometric design.

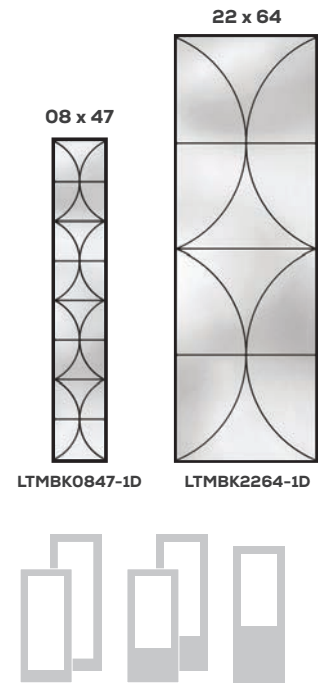

HOMeward™ †

Glass Privacy Rating 1 4 10

The balanced Mission-style pattern of Homeward invites light to cascade through its distinctive clear bevels, seeded glass and gray artique glass. An ideal complement for a Transitional home design.

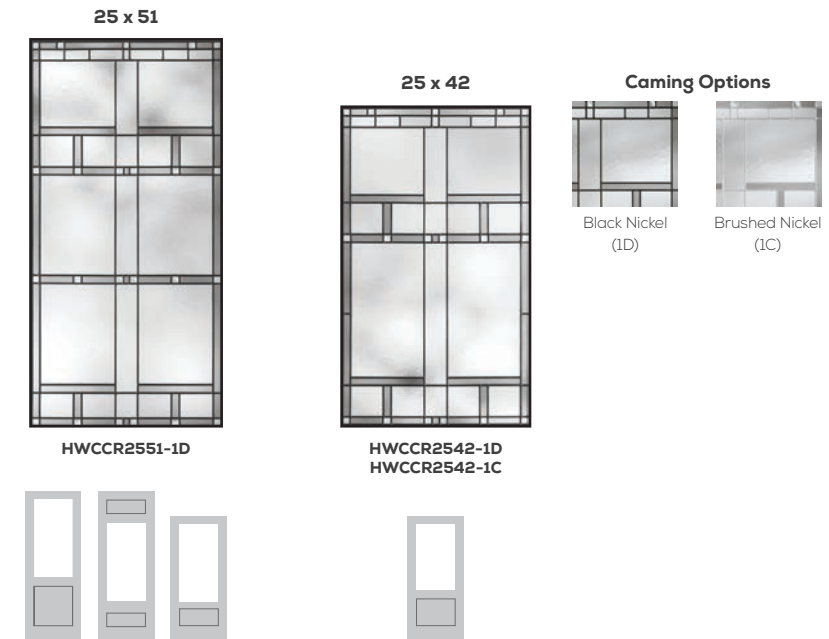

millwork.bc.com
11011 E 104th Ave, Suite 1000
Commerce City, CO 80640
720-653-3333
DenverMillwork@bc.com

Stock status is subject to availability, please contact your Boise Cascade Millwork Representative with any questions.

† = TWO WEEK LEAD TIME
PRODUCT IMAGES SHOW EXTERIOR SIDE OF DOOR.



thermatru.com | 1-800-THERMA-TRU | 20



Boise Cascade®
MILLWORK

TEXAS STAR†

Glass Privacy Rating 1 5 10

Beautifully crafted with clear bevels, curved bevels, clear waterglass, granite glass, glue chip glass, there's no mistaking the inspiration for this recognizable design. Strong, independent and all-American.

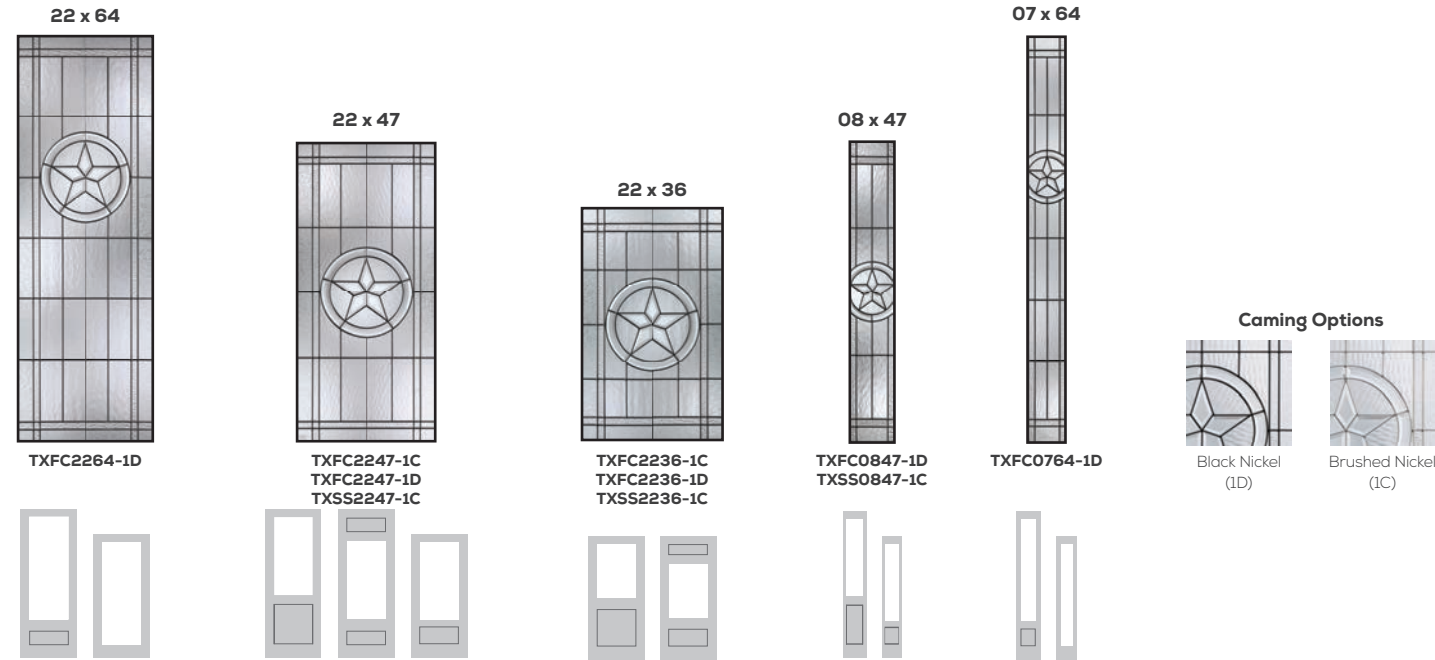

AUGUSTINE®†

Glass Privacy Rating 1 10

Augustine's swirl leaf design adds a touch of elegance. Made of round wrought iron and granite glass for ultimate privacy, Augustine pays homage to classic English styling.



Boise Cascade®
MILLWORK

millwork.bc.com
11011 E 104th Ave, Suite 1000
Commerce City, CO 80640
720-653-3333
DenverMillwork@bc.com

Stock status is subject to availability, please contact your Boise Cascade Millwork Representative with any questions.

† = TWO WEEK LEAD TIME
PRODUCT IMAGES SHOW EXTERIOR SIDE OF DOOR.

THERMA TRU®
DOORS

thermatru.com | 1-800-THERMA-TRU | 22



Boise Cascade®
MILLWORK

BORRASSA®†

Glass Privacy Rating 1 10

A statement of strength and beauty, Borrassa combines linear and curved wrought iron with hammered glass for ultimate privacy. Wrought iron decorative accents add an authentic Old World feel to this stately design.

Caming Options



Wrought Iron

25 x 51



BACCW2551-KC-1W†

25 x 51 Arched



BACCW2551A-KC-1W†

25 x 42



BACCW2542-KC-1W†

25 x 42 Arched



BACCW2542A-KC-1W

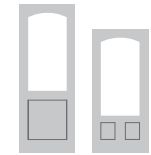
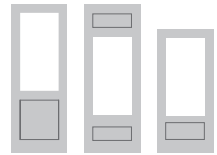

LUCERNA®†

Glass Privacy Rating 1 10

Named for the beauty of light it reflects, Lucerna glass presents an elegant, updated fleur-de-lis pattern in a spectrum of curved, diamond and rectangular bevels surrounded by smooth, swirling barn wood and heavily textured diamond border glass.

Caming Options



Black Nickel (1D)



Brushed Nickel (1C)

25 x 51



LCCCR2551-1C
LCCCR2551-1D

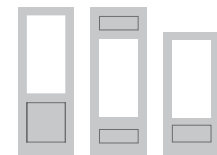

25 x 42

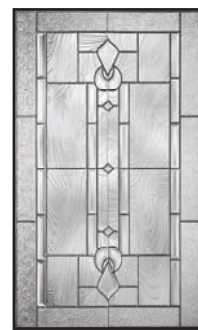

LCCCR2542-1C
LCCCR2542-1D



SARATOGA™

Glass Privacy Rating 1 10

Saratoga evokes a certain urban sophistication while offering modest privacy with its clear bevels, diamond glass, reed glass and caming. The geometric pattern bridges both modern and traditional designs.

Caming Options



Black Nickel (1D)



Brushed Nickel (1C)

22 x 64



SGFC2264-1C
SGFC2264-1D



22 x 47



SGFC2247-1C
SGFC2247-1D

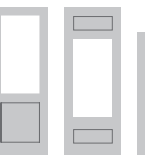

FC = BUFF
SS = SMOOTH

PRODUCT IMAGES SHOW EXTERIOR SIDE OF DOOR.

THERMA TRU®
DOORS

thermatru.com | 1-800-THERMA-TRU |



Boise Cascade®
MILLWORK

millwork.bc.com
11011 E 104th Ave, Suite 1000
Commerce City, CO 80640
720-653-3333
DenverMillwork@bc.com

† = TWO WEEK LEAD TIME
PRODUCT IMAGES SHOW EXTERIOR SIDE OF DOOR.



Boise Cascade
MILLWORK

RISERVA®

Glass Privacy Rating 1 10

Riserva combines ocean glass with linear and curved wrought iron elements to create a simple yet elegant design. A perfect way to let natural light in while achieving ultimate privacy.

Caming Options



Wrought Iron

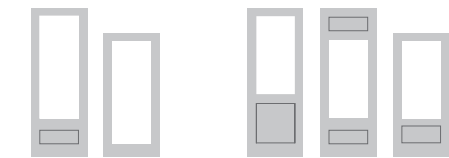
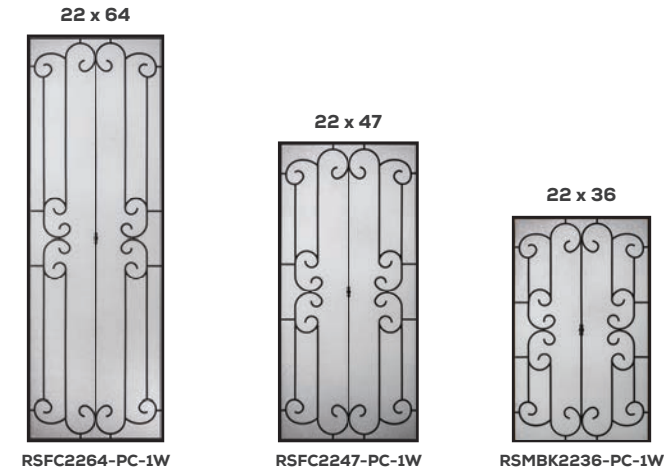

AXIS®

Glass Privacy Rating 1 10

Simple and smart, Axis combines narrow reed glass in horizontal and vertical arrangements to create stunning contrast and modest privacy. A vertical band of clear glass bevels completes this linear design, ideal for Modern home styles.

Caming Options



Black Nickel (1D)

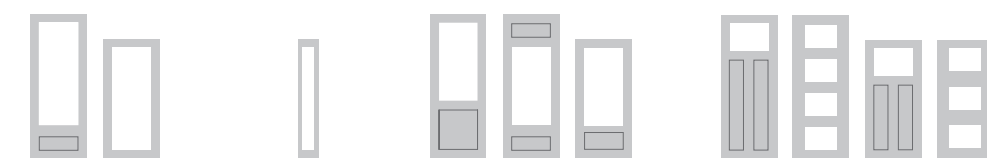
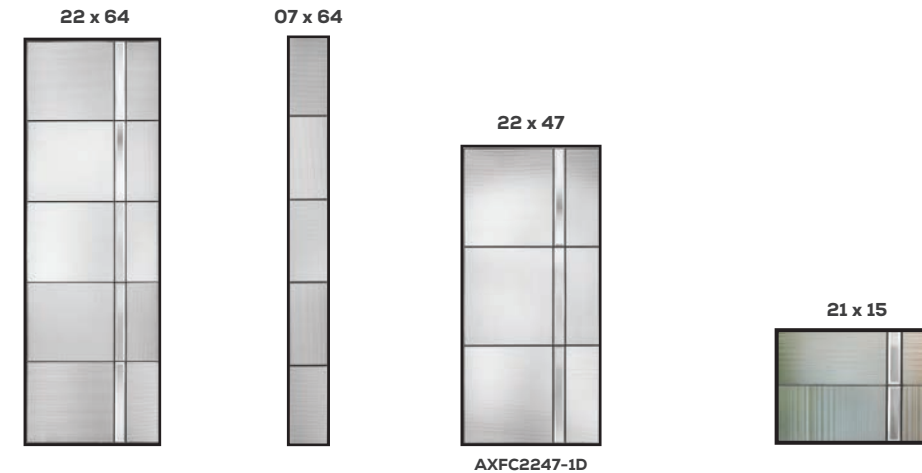

PEMBRIDGE™

Glass Privacy Rating 1 10

Simplistic in its design, Pembridge features a field of hammered glass framed by gray baroque glass and multifaceted bevels. A central diamond shape adds a decorative touch.

Caming Options



Black Nickel (1D)



Brushed Nickel (1C)

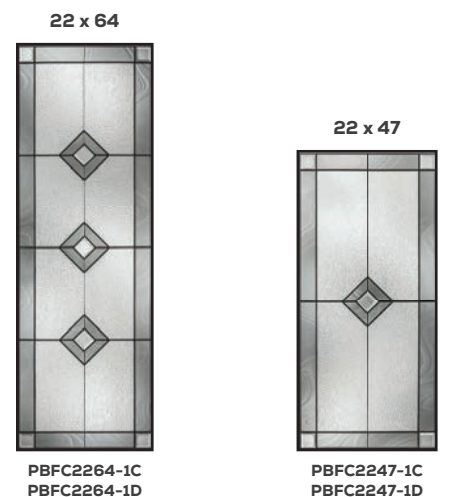

CE = LOW-E
FC = BUFF
SS = SMOOTH

PRODUCT IMAGES SHOW EXTERIOR SIDE OF DOOR.

THERMA-TRU
DOORS

thermatru.com | 1-800-THERMA-TRU |



Boise Cascade
MILLWORK

millwork.bc.com
11011 E 104th Ave, Suite 1000
Commerce City, CO 80640
720-653-3333
DenverMillwork@bc.com

Stock status is subject to availability, please contact your Boise Cascade Millwork Representative with any questions.



INTERNAL BLINDS

Internal blinds provide the privacy and convenience of a cordless blind enclosed between glass. Control the desired level of light and privacy with a single handle that opens, closes and tilts the blinds.

22 x 80	20 x 80		
VBRFC-2280 VBRFC-2280-CE VBRSS-2280 VBRSS-2280-CE	VBRFC-2080 VBRFC-2080-CE VBRSS-2080 VBRSS-2080-CE		
		22 x 64	20 x 64
		VBRFC-2264 VBRFC-2264-CE VBRSS-2264 VBRSS-2264-CE	VBRFC-2064 VBRFC-2064-CE VBRSS-2064 VBRSS-2064-CE
		16 x 64	07 x 64
VBRSS-1664 VBRSS-1664-CE	VBRSS-0764 VBRSS-0764-CE		
		22 x 47	22 x 36
		VBRFC-2247 VBRFC-2247-CE VBRSS-2247 VBRSS-2247-CE	VBRFC-2236 VBRFC-2236-CE VBRSS-2236 VBRSS-CE
		20 x 36	
		VBRSS-2036	

REEDED

Glass Privacy Rating 1 **7** 10

Refined, transitional style. The clean lines of Reeded glass bring a modern look to the home, featuring a vertical, linear texture. Reeded glass provides ample natural light while maintaining moderate privacy.

21 x 15	8 x 6
XKSSZ2115-A	XKSS0806-X

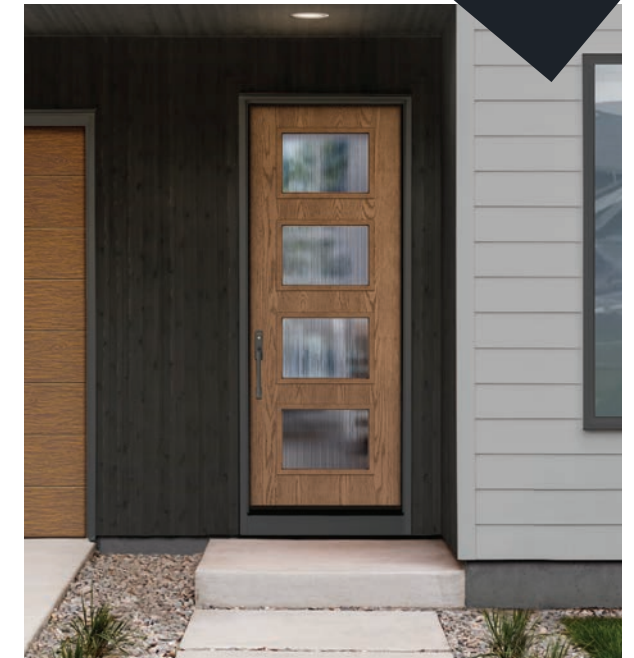

FC = BUFF
SS = SMOOTH
Z = FLAT FRAME

PRODUCT IMAGES SHOW EXTERIOR SIDE OF DOOR.

CE = LOW-E
FC = BUFF
SS = SMOOTH

PRODUCT IMAGES SHOW EXTERIOR SIDE OF DOOR.





SATIN ETCH

22 x 80
XEES2280

07 x 80
XEESZ0780

22 x 64
XEES2264

07 x 64
XEFCZ0764
XEES0764
XEESZ0764



22 x 47
XEES2247

22 x 36
XEES2236

21 x 15
XEFCZ2115
XEES2115
XEESZ2115

21 x 15
XEMBK2115-A

8 x 6
XEFCZ0806
XEES0806
XEESZ0806



CHORD

Glass Privacy Rating 1  10

A vertical flowing pattern reminiscent of waves on the water.

07 x 80
XCSSZ0780

22 x 64
XCSS2264

07 x 64
XCFCZ0764
XCSS0764
XCSSZ0764

22 x 47
XCSS2247

22 x 36
XCSS2236

21 x 15
XCSS2115
XCSSZ2115

8 x 6
XCFCZ0806
XCSS0806
XCSSZ0806

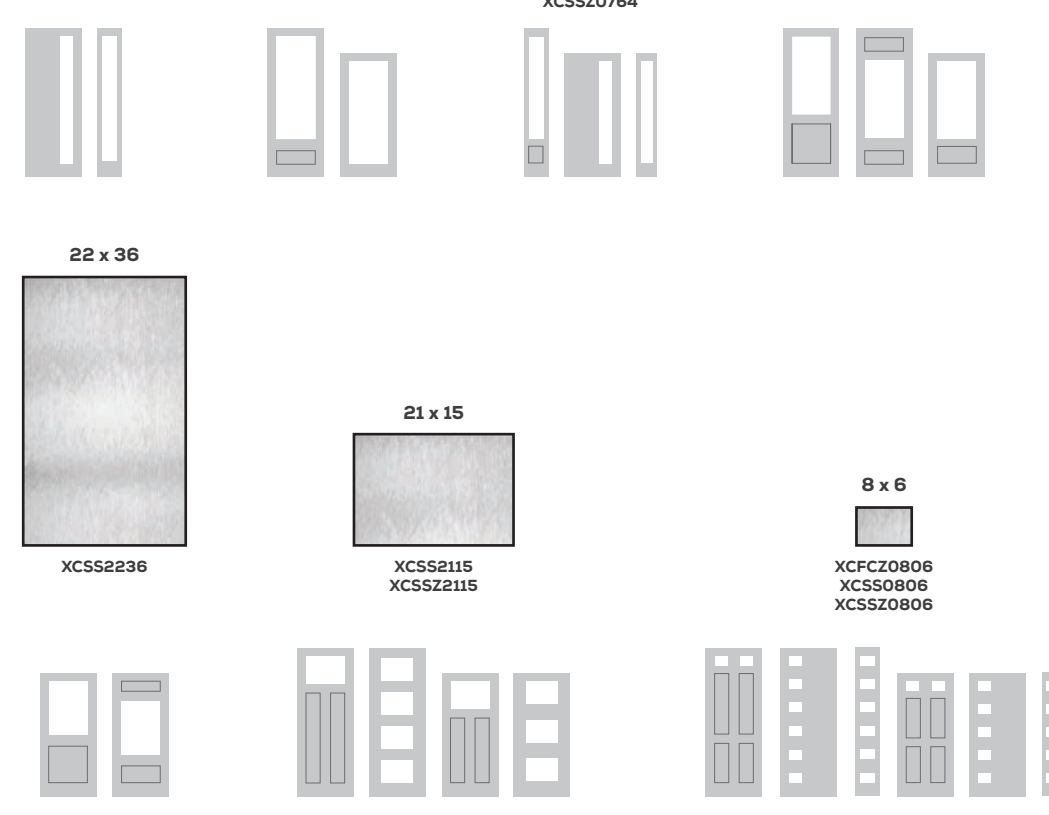

FC = BUFF
SS = SMOOTH
Z = FLAT FRAME

PRODUCT IMAGES SHOW EXTERIOR SIDE OF DOOR.

Stock status is subject to availability, please contact your Boise Cascade Millwork Representative with any questions.





CHINCHILLA

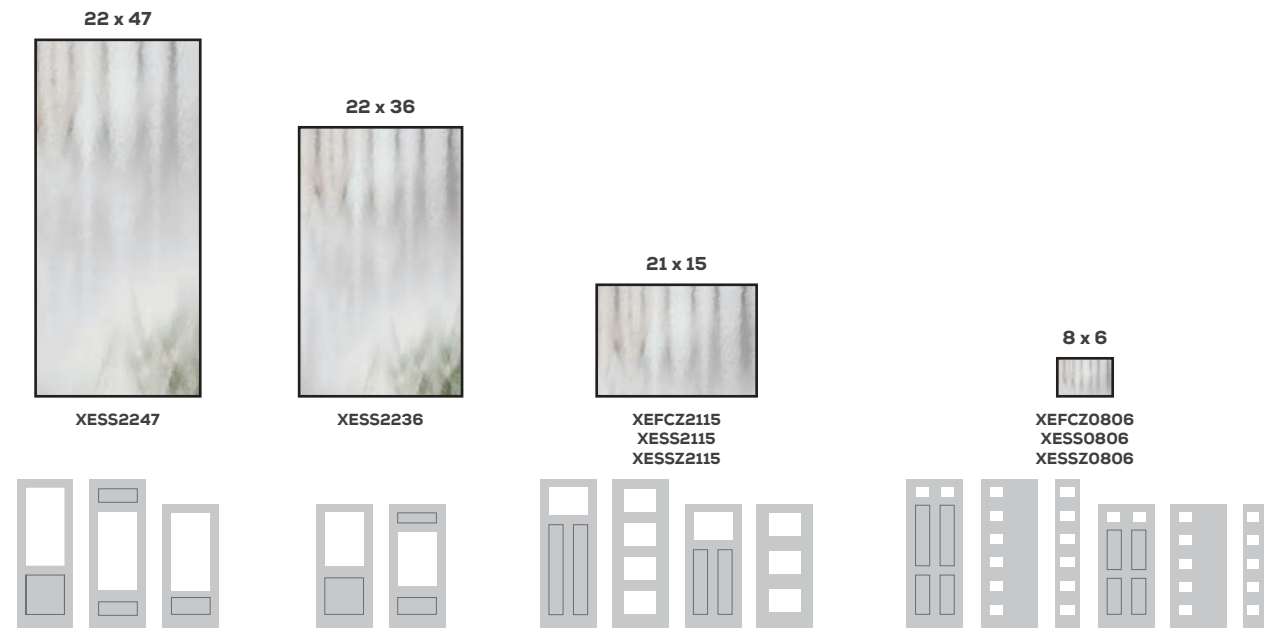

RAINGLASS

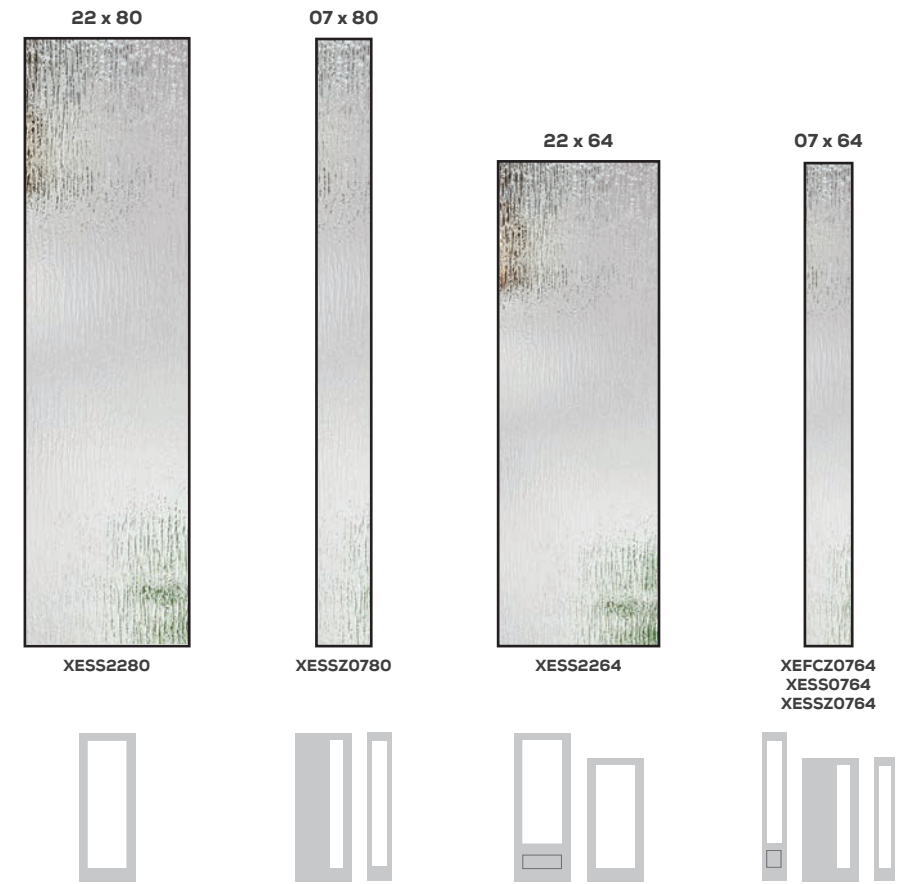



Boise Cascade®
MILLWORK

GRANITE

Glass Privacy Rating 1 10

A coarse-grained arrangement with surface detail over the entirety of the glass.

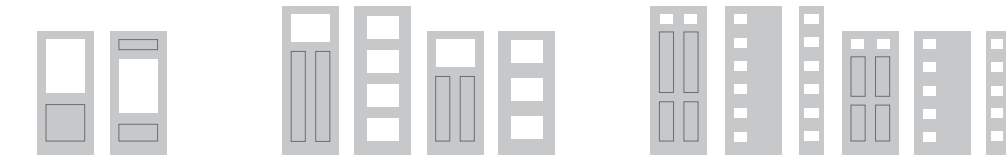
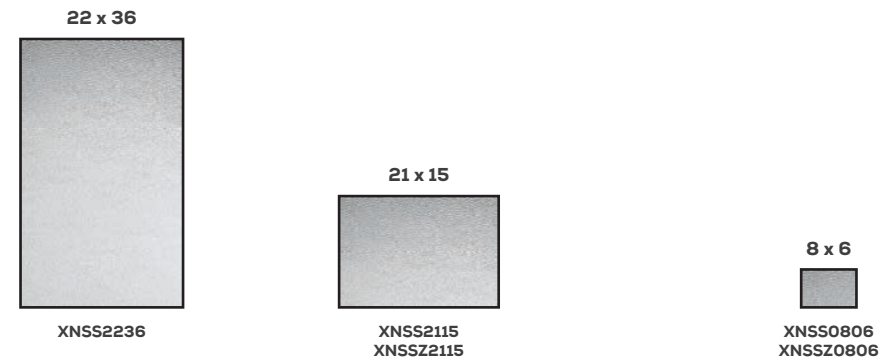
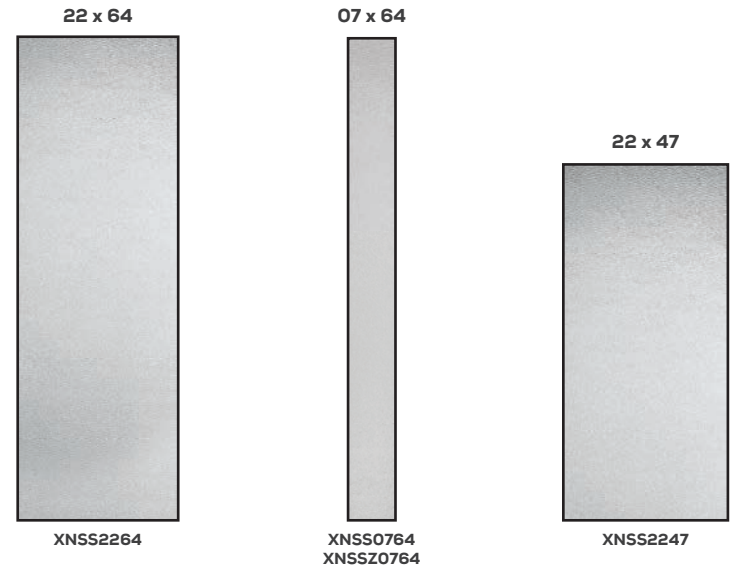

DIVIDED LITES

Simulated Divided Lites (SDL)



Grilles Between Glass (GBG)



Fixed Grilles (FXG)



Low-E Glass



In cold weather, Low-E glass reflects the heat back inside to help keep your home warm.

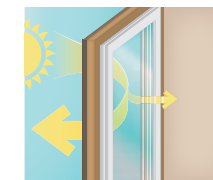

In warm weather, Low-E glass reflects the sun's rays off of the glass to help keep your home cool.



Boise Cascade®
MILLWORK

millwork.bc.com
11011 E 104th Ave, Suite 1000
Commerce City, CO 80640
720-653-3333
DenverMillwork@bc.com

FC = BUFF
SS = SMOOTH
Z = FLAT FRAME

PRODUCT IMAGES SHOW EXTERIOR SIDE OF DOOR.

THERMA TRU®
DOORS



CLEAR GLASS

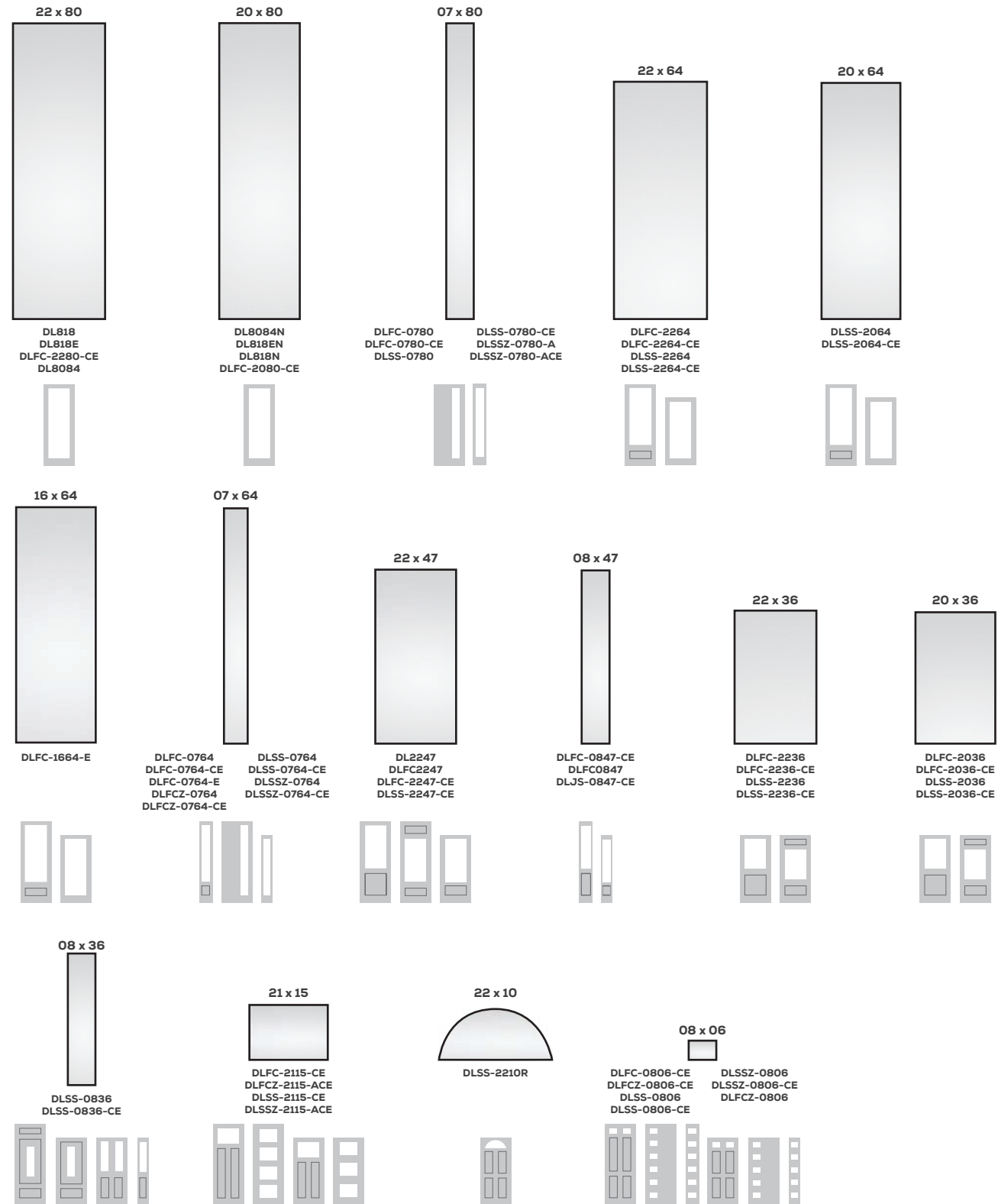

GRILLES

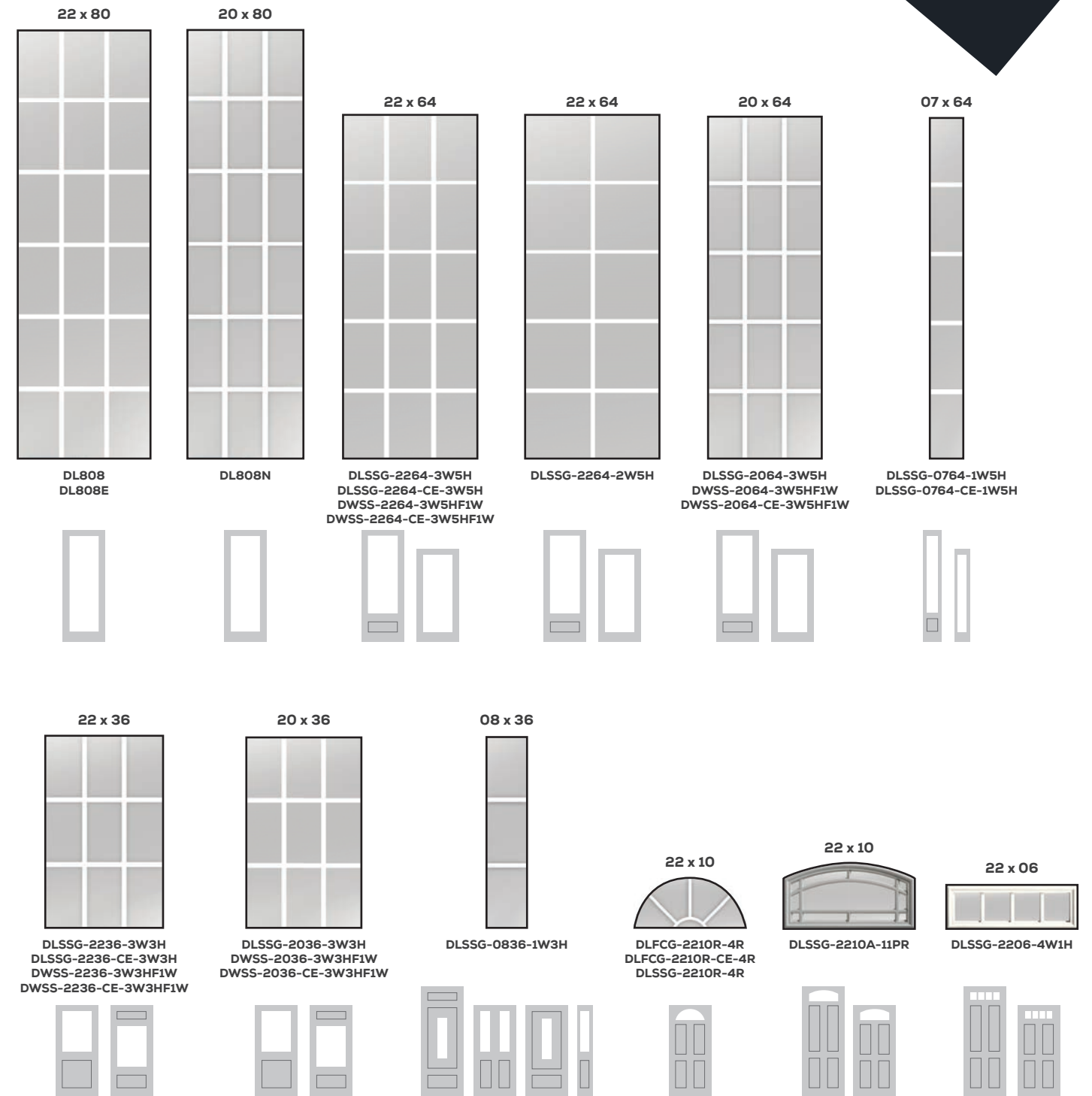

CE = LOW-E
FC = BUFF
SS = SMOOTH
Z = FLAT FRAME

PRODUCT IMAGES SHOW EXTERIOR SIDE OF DOOR.





Boise Cascade
MILLWORK

FRAMES

Composite Frames - Smooth



Description	Material	Part #	Size
FRAME COMPOSITE SMOOTH RAW IS LH HD/SILL	Composite	JCSN4IL68HHSG*	6/8 4-9/16
FRAME COMPOSITE SMOOTH RAW IS RH HD/SILL	Composite	JCSN4IR68HHSG*	6/8 4-9/16
FRAME COMPOSITE SMOOTH RAW IS LH HD/SILL	Composite	JCSN4IL80HHSG*	8/0 4-9/16
FRAME COMPOSITE SMOOTH RAW IS RH HD/SILL	Composite	JCSN4IR80HHSG*	8/0 4-9/16
FRAME COMPOSITE SMOOTH RAW IS LH HD/SILL	Composite	JCSN6IL68HHSG*	6/8 6-9/16
FRAME COMPOSITE SMOOTH RAW IS RH HD/SILL	Composite	JCSN6IR68HHSG*	6/8 6-9/16
FRAME COMPOSITE SMOOTH RAW IS LH HD/SILL	Composite	JCSN6IL80HHSG*	8/0 6-9/16
FRAME COMPOSITE SMOOTH RAW IS RH HD/SILL	Composite	JCSN6IR80HHSG*	8/0 6-9/16
HEADER COMPOSITE SMOOTH RAW BK SKID	Composite	JCSN430U1B*	3/0 4-9/16 U1
FRAME COMPOSITE SMOOTH RAW TRIPLE W/ MULL BK SKID	Composite	JCSN490WMU1B*	9/0 4-9/16 U1
HEADER COMPOSITE SMOOTH RAW BK SKID	Composite	JCSN630U1B*	3/0 6-9/16 U1
FRAME COMPOSITE SMOOTH RAW TRIPLE W/ MULL BK	Composite	JCSN690WMU1B*	9/0 6-9/16 U1

Composite Frames - Grained

Description	Material	Part #	Size
FRAME COMPOSITE GRAINED RAW IS LH HD/SILL	Composite	JCGN4IL68HHSG*	6/8 4-9/16
FRAME COMPOSITE GRAINED RAW IS RH HD/SILL	Composite	JCGN4IR68HHSG*	6/8 4-9/16
FRAME COMPOSITE GRAINED RAW IS LH HD/SILL	Composite	JCGN4IL80HHSG*	8/0 4-9/16
FRAME COMPOSITE GRAINED RAW IS RH HD/SILL	Composite	JCGN4IR80HHSG*	8/0 4-9/16
FRAME COMPOSITE GRAINED RAW IS LH HD/SILL	Composite	JCGN6IL68HHSG*	6/8 6-9/16
FRAME COMPOSITE GRAINED RAW IS RH HD/SILL	Composite	JCGN6IR68HHSG*	6/8 6-9/16
FRAME COMPOSITE GRAINED RAW IS LH HD/SILL	Composite	JCGN6IL80HHSG*	8/0 6-9/16
FRAME COMPOSITE GRAINED RAW IS RH HD/SILL	Composite	JCGN6IR80HHSG*	8/0 6-9/16
FRAME COMPOSITE GRAINED RAW TRIPLE W/ MULL BK SKID JCGN490WMU1B JCGN490WMU1B-S	Composite	JCGN490WMU1B*	9/0 4-9/16 U1
FRAME COMPOSITE GRAINED RAW TRIPLE W/ MULL BK JCGN690WMU1B JCGN690WMU1B-S	Composite	JCGN690WMU1B*	9/0 6-9/16 U1
HEADER COMPOSITE WOODGRAIN RAW BLANK JCGN430U1B JCGN430U1B-S	Composite	JCGN430U1B*	3/0 4-9/16 U1
HEADER COMPOSITE WOODGRAIN RAW BLANK JCGN630U1B JCGN630U1B-S	Composite	JCGN630U1B*	3/0 6-9/16 U1

Other Frames

Description	Material	Part #	Size
FRAME HEAD RUSTIC ARCH TOP FRAME	Primed Pine	JHA430U1WP	3/0 4-9/16 U1
FRAME HEAD RUSTIC ARCH TOP FRAME	Primed Pine	JHA436U1WP	3/6 4-9/16 U1
FRAME HEAD RUSTIC ARCH TOP FRAME	Primed Pine	JHA630U1WP	3/0 6-9/16 U1
FRAME HEAD RUSTIC ARCH TOP FRAME	Primed Pine	JHA636U1WP	3/6 6-9/16 U1
FRAME HEAD RUSTIC RADIUS TOP FRAME†	Primed Pine	JHR430U1WP	3/0 4-9/16 U1
FRAME HEAD RUSTIC RADIUS TOP FRAME†	Primed Pine	JHR436U1WP	3/6 4-9/16 U1
FRAME HEAD RUSTIC RADIUS TOP FRAME†	Primed Pine	JHR630U1WP	3/0 6-9/16 U1
FRAME HEAD RUSTIC RADIUS TOP FRAME†	Primed Pine	JHR636U1WP	3/6 6-9/16 U1

FASTENERS SETTING TOOL & SCREW PLUG COVERS

Jamb screw plugs hide unsightly screws, allowing jamb to be installed with screws through its thickest part for better aesthetics and long-term performance.

Screw plugs are available on a collated strip for ease of installation and finishing.

Description	Part #	Size
JAMB PLUG COMPOSITE SMOOTH RAW	JAMB	JPCSN
JAMB PLUG INSTALLATION SCREWS	JAMB	JPSCREW
JAMB PLUG INSTALLATION TOOL	JAMB	JPTOOL



COMPOSITE ENTRY MULLION



2" Entry Narrow
 2-1/2" Entry Wide

Description	Material	Part #	Size
MULL COMPOSITE SMOOTH RAW ENTRY NARROW IS BLANK HD/SILL	Composite	MCSNENIB80HHSG*	8/0 X 2"
MULL COMPOSITE SMOOTH RAW ENTRY NARROW IS BLANK HD/SILL	Composite	MCSNENIB80HHSG*	8/0 X 2 1/2"
MULL COMPOSITE GRAINED RAW ENTRY NARROW IS BLANK HD/SILL	Composite	MCGNENIB80HHSG*	8/0 X 2"
MULL COMPOSITE GRAINED RAW ENTRY NARROW IS BLANK HD/SILL	Composite	MCGNENIB80HHSG*	8/0 X 2 1/2"

COMPOSITE PATIO MULLION



2" Patio Narrow

Description	Material	Part #	Size
MULL COMPOSITE GRAINED RAW PATIO NARROW IS BLANK HD/SILL	Composite	MCGNPNI80HHSG*	8/0 X 2"
MULL COMPOSITE GRAINED RAW PATIO NARROW IS BLANK HD/SILL	Composite	MCGNPNI80HHSG*	8/0 X 2 1/2"

COVE MOULD



7/16" x 5/16" Cove Mould

Description	Application	Material	Part #	Size
COVE MOULD COMPOSITE SMOOTH RAW	Inswing	Composite	CMCSN68LN	6/8
COVE MOULD COMPOSITE SMOOTH RAW	Inswing	Composite	CMCSN80LN	8/0

BRICKMOULD



2" Brickmould WM180

Description	Application	Material	Part #	Size
BRICKMOULD COMPOSITE SMOOTH RAW IS HEAD	Inswing	Composite	BMCSNI30U1	3/0 U1
BRICKMOULD COMPOSITE SMOOTH RAW IS LH U1	Inswing	Composite	BMCSNIL68H	6/8
BRICKMOULD COMPOSITE SMOOTH RAW IS RH U1	Inswing	Composite	BMCSNIR68H	6/8
BRICKMOULD COMPOSITE SMOOTH RAW IS HEAD	Inswing	Composite	BMCSNI28U1	2/8 U1
BRICKMOULD COMPOSITE SMOOTH RAW IS BLANK U1	Inswing	Composite	BMCSNIB90WBK	9/0
BRICKMOULD COMPOSITE SMOOTH RAW IS LH U1	Inswing	Composite	BMCSNIL80H	8/0
BRICKMOULD COMPOSITE SMOOTH RAW IS RH U1	Inswing	Composite	BMCSNIR80H	8/0

Additional Brickmould:

Description	Material	Part #	Size
BRICKMOULD RUSTIC ARCH TOP†	Primed Pine	BMH30U1A	3/0 U1
BRICKMOULD RUSTIC ARCH TOP†	Primed Pine	BMH36U1A	3/6 U1
BRICKMOULD RUSTIC RADIUS TOP†	Primed Pine	BMH30U1R	3/0 U1
BRICKMOULD RUSTIC RADIUS TOP†	Primed Pine	BMH36U1R	3/6 U1

PRE-INSERTED WEATHERSTRIP OPTION AVAILABLE FOR SELECT WHITE SMOOTH JAMBS AND MULLIONS PRE-MACHINED FOR HINGES AND LOCKS.

*SEE THE THERMA-TRU ARCHITECTURAL DETAILS & COMPONENTS MANUAL FOR ACTUAL UNIT SIZE SPECIFICATIONS.

† - TWO WEEK LEAD TIME



Boise Cascade
MILLWORK

millwork.bc.com

11011 E 104th Ave, Suite 1000

Commerce City, CO 80640

720-653-3333

DenverMillwork@bc.com

THERMA-TRU
DOORS

thermatru.com | 1-800-THERMA-TRU |



SILLS

Allow for a tight seal to help block wind-driven moisture infiltration at the bottom of the door and a solid stepping surface. Available in a variety of materials with features to meet the needs of different climates and exposures. Ask your Therma-Tru seller for a complete list of options.

Sill Finishes



Mill



Bronze

Cap Colors



Darkwood

Inswing Composite Adjustable Sill



Composite Adjustable Sill (Premium)

- Thick wood-grained composite cap and nosing.
- U-shaped weather seal.
- Adjustable flush stainless steel screws.

Continuous length with spread mullion capability to fill 49"-75" rough openings.*

Description	Application	Part #	Size
IS SILL TRU DEF ADJUSTABLE COMPOSITE W/ 7/8 ASTRAGAL BRONZE DARK WOOD CAP NO SCREEN	Inswing	ISL3AS5EF587UNBD	5/8 5-3/4 U1
IS SILL NO SCREEN ADJUSTABLE STANDARD COMPOSITE W/ 7/8 ASTRAGAL BRONZE DARK WOOD CAP	Inswing	ISL3AS5EF607UNBD	6/0 5-3/4 U1
IS SILL NO SCREEN ADJUSTABLE STANDARD COMPOSITE LINEAL BRONZE DARK WOOD CAP	Inswing	ISL3AS5EN90UNBD	9/0 5-3/4 U1
IS SILL TRU DEF ADJUSTABLE COMPOSITE LINEAL MILL FINISH LIGHT WOOD CAP NO SCREEN RAIL	Inswing	ISL3AS5EN90UNML	9/0 5-3/4 U1
IS SILL TRU DEF ADJUSTABLE COMPOSITE BRONZE DARK WOOD CAP NO SCREEN	Inswing	ISL3AS5ES28UNBD*	2/8 5-3/4 U1
IS SILL TRU DEF ADJUSTABLE COMPOSITE BRONZE DARK WOOD CAP NO SCREEN	Inswing	ISL3AS5ES30UNBD*	3/0 5-3/4 U1
IS SILL NO SCREEN ADJUSTABLE STANDARD COMPOSITE BRONZE DARK WOOD CAP	Inswing	ISL3AS5ES36UNBD	3/6 5-3/4 U1
IS SILL TRU DEF ADJUSTABLE COMPOSITE PATIO DOUBLE LH BRONZE DARK WOOD CAP	Inswing	ISL3AS5PD50ULNBD	5/0 5-3/4 U1
IS SILL TRU DEF ADJUSTABLE COMPOSITE PATIO DOUBLE RH BRONZE DARK WOOD CAP	Inswing	ISL3AS5PD50URNBD	5/0 5-3/4 U1
IS SILL TRU DEF ADJUSTABLE COMPOSITE PATIO DOUBLE LH BRONZE DARK WOOD CAP	Inswing	ISL3AS5PD54ULNBD	5/4 5-3/4 U1
IS SILL TRU DEF ADJUSTABLE COMPOSITE PATIO DOUBLE RH BRONZE DARK WOOD CAP	Inswing	ISL3AS5PD54URNBD	5/4 5-3/4 U1
IS SILL TRU DEF ADJUSTABLE COMPOSITE PATIO DOUBLE LH BRONZE DARK WOOD CAP	Inswing	ISL3AS5PD58ULNBD	5/8 5-3/4 U1
IS SILL TRU DEF ADJUSTABLE COMPOSITE PATIO DOUBLE RH BRONZE DARK WOOD CAP	Inswing	ISL3AS5PD58URNBD	5/8 5-3/4 U1
IS SILL ADJUSTABLE STANDARD COMPOSITE PATIO DOUBLE LH BRONZE DARK WOOD CAP	Inswing	ISL3AS5PD60ULNBD	6/0 5-3/4 U1
IS SILL ADJUSTABLE STANDARD COMPOSITE PATIO DOUBLE RH BRONZE DARK WOOD CAP	Inswing	ISL3AS5PD60URNBD	6/0 5-3/4 U1
IS SILL ADJUSTABLE STANDARD COMPOSITE PATIO LINEAL BRONZE DARK WOOD CAP	Inswing	ISL3AS5PN90UNBD	9/0 5-3/4 U1

Outswing Composite Outswing Sill



- Thick wood-grained composite cap and nosing.
- Integrated weatherstrip.

Description	Application	Part #	Size
TRU-DEFENSE OS SILL STANDARD COMPOSITE FIXED MILL FINISH DARK WOOD CAP BRONZE WEATHERSTRIP	Outswing	OSE28USF5MDB*	2/8 5-3/4 U1
TRU-DEFENSE OS SILL COMPOSITE MILL FINISH LIGHT WOOD CAP BRNZ WEATHERSTRIP	Outswing	OSE28USF5MLB*	2/8 5-3/4 U1
TRU-DEFENSE OS SILL STANDARD COMPOSITE FIXED BRONZE DARK WOOD CAP BRONZE WEATHERSTRIP	Outswing	OSE30USF5BDB*	2/8 5-3/4 U1
TRU-DEFENSE OS SILL STANDARD COMPOSITE FIXED BRONZE DARK WOOD CAP BRONZE WEATHERSTRIP	Outswing	OSE30USF5BDB*	3/0 5-3/4 U1
TRU-DEFENSE OS SILL STANDARD COMPOSITE FIXED MILL FINISH DARK WOOD CAP BRONZE WEATHERSTRIP	Outswing	OSE30USF5MDB*	3/0 5-3/4 U1
TRU-DEFENSE OS SILL COMPOSITE MILL FINISH LIGHT WOOD CAP BRNZ WEATHERSTRIP	Outswing	OSE30USF5MLB*	3/0 5-3/4 U1
TRU-DEFENSE OS SILL W/ 7/8 ASTRAGAL COMPOSITE FIXED BRONZE DARK WOOD CAP BRONZE WEATHERSTRIP	Outswing	OSE507USF5BDB	5/0 5-3/4 U1
TRU-DEFENSE OS SILL W/ 7/8 ASTRAGAL STANDARD COMPOSITE FIXED BRONZE DARK WOOD CAP BRONZE WEATHERSTRIP	Outswing	OSE607USF5BDB	6/0 5-3/4 U1
TRU-DEFENSE OS SILL W/ 7/8 ASTRAGAL COMPOSITE FIXED MILL FINISH LIGHT WOOD CAP BRNZ WEATHERSTRIP	Outswing	OSE607USF5MLB	6/0 5-3/4 U1
TRU-DEFENSE OS SILL COMPOSITE FIXED MILL FINISH LIGHT WOOD CAP BRNZ WEATHERSTRIP CONTINUOUS PATIO OS	Outswing	OSE60USF5MLB	6/0 5-3/4 U1

Value Composite Adjustable Sill

Description	Application	Sill Finish	Sill Cap Color	Part #	Size
INSWING MILL DARKWOOD	Inswing	Mill	Darkwood	ISIL3AP4ES28UNMD	2/8 4-9/16 U1
INSWING MILL DARKWOOD	Inswing	Mill	Darkwood	ISIL3AP4ES30UNMD	3/0 4-9/16 U1
INSWING BRONZE DARKWOOD	Inswing	Bronze	Darkwood	ISIL3AP4ES28UNBD	2/8 4-9/16 U1
INSWING BRONZE DARKWOOD	Inswing	Bronze	Darkwood	ISIL3AP4ES30UNBD	3/0 4-9/16 U1
INSWING MILL DARKWOOD	Inswing	Mill	Darkwood	ISIL3AP5ES28UNMD	2/8 5-3/4 U1
INSWING MILL DARKWOOD	Inswing	Mill	Darkwood	ISIL3AP5ES30UNMD	3/0 5-3/4 U1
INSWING BRONZE DARKWOOD	Inswing	Bronze	Darkwood	ISIL3AP5ES28UNBD	2/8 5-3/4 U1
INSWING BRONZE DARKWOOD	Inswing	Bronze	Darkwood	ISIL3AP5ES30UNBD	3/0 5-3/4 U1

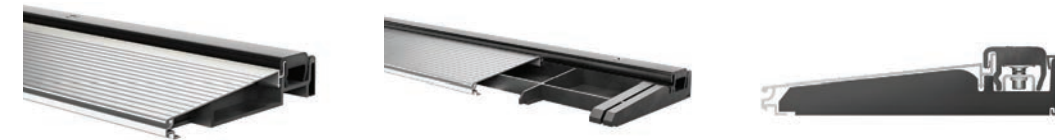



Boise Cascade[®]
MILLWORK

Public Access Sill With or Without Thermal Break
(For ADA Applications**)

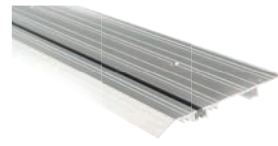

- All-aluminum construction.
- Ramp slope meets Americans with Disabilities Act (ADA) requirements.

Description	Part #	Size
PUBLIC ACCESS SILL THERMAL BREAK BRONZE	S430PATBU1	3/0 4-9/16 U1
PUBLIC ACCESS SILL THERMAL BREAK MILL	S430PATU1	3/0 4-9/16 U1
PUBLIC ACCESS SILL THERMAL BREAK BRONZE	S460PATBU1	6/0 4-9/16 U1
PUBLIC ACCESS SILL THERMAL BREAK MILL	S460PATU1	6/0 4-9/16 U1
PUBLIC ACCESS SILL THERMAL BREAK BRONZE	S630PATBU1	3/0 6-9/16 U1
PUBLIC ACCESS SILL THERMAL BREAK MILL	S630PATU1	3/0 6-9/16 U1
PUBLIC ACCESS SILL THERMAL BREAK BRONZE	S660PATBU1	6/0 6-9/16 U1
PUBLIC ACCESS SILL THERMAL BREAK MILL	S660PATU1	6/0 6-9/16 U1

Sill Pan
(Recommended) ❖



- Fits between the sill and subfloor for an added layer of protection against moisture.
- Engineered with sloped channels to help collect and drain moisture away.

Description	Part #	Size
SILL PAN MAX FRAME	TTSLPAN430	3/0 4-9/16
SILL PAN MAX FRAME	TTSLPAN460	6/0 4-9/16
SILL PAN MAX FRAME	TTSLPAN490	9/0 4-9/16
SILL PAN MAX FRAME	TTSLPAN630	3/0 6-9/16
SILL PAN MAX FRAME	TTSLPAN660	6/0 6-9/16
SILL PAN MAX FRAME	TTSLPAN690	9/0 6-9/16

Sill Covers
(Recommended)

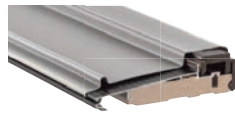

- Fits over the sill to help protect cap and finish from damage during installation.
- Made of a heavy-duty material to withstand wear.
- Available in a variety of options to fit our sills.

Shown over composite adjustable sill.

Description	Part #	Size
TRU-DEFENSE OS SILL COVER BULK	TDOCOV530B	3/0 5-3/4
TRU-DEFENSE R&R SILL COVER BULK	TD3SC5300B	3/0 5-5-3/4

Sill Extenders

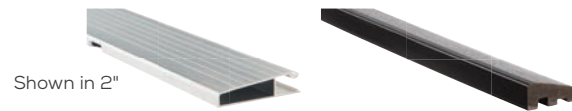

Finishes:
Darkwood (Premium)
2"

Description	Finish	Part #	Size
TRU-DEFENSE OS SILL EXTENDER DARK WOOD	Darkwood	TDOSSN60D	2"X72
TRU-DEFENSE SILL EXTENDER BRONZE FINISH	Bronze	SETD130X2B	2"X13/0
TRU-DEFENSE SILL EXTENDER BRONZE FINISH	Bronze	SETD30UX2B	2"X3/0 U1
TRU-DEFENSE SILL EXTENDER MILL FINISH	Mill	SETD130X2M	2"X13/0
TRU-DEFENSE SILL EXTENDER MILL FINISH	Mill	SETD30UX2M	2"X3/0 U1
TRU-DEFENSE PATIO SILL EXTENDER BRONZE FINISH	Bronze	SETD60PUX2B	2"X6/0 U1
TRU-DEFENSE PATIO SILL EXTENDER MILL FINISH	Mill	SETD60PUX2M	2"X6/0 U1

DOOR BOTTOMS

Designed to mate with our sills and help provide added protection to help seal the margin between the door and sill. Kerf-applied for a secure fit and made of a heavy-duty material that holds its shape to help maintain contact.

Dual Bulb Kerf-Applied Door Bottom for Composite Adjustable, Basic Composite Adjustable, Hardwood Adjustable Sills ❖



Sills:
Composite Adjustable
Hardwood Adjustable
Basic Composite Adjustable
Color:
Bronze

Description	Application	Part #	Size
DOOR BOTTOM IS DP ACTIVE BRONZE	Inswing	DBDBU260B	2/6 U1
DOOR BOTTOM IS DP ACTIVE BRONZE	Inswing	DBDBU360B	3/6 U1
DOOR BOTTOM IS DP ACTIVE BRONZE 50 PER PACK	Inswing	DBDBU280B-50	2/8 U1
DOOR BOTTOM IS DP ACTIVE BRONZE 50 PER PACK	Inswing	DBDBU300B-50	3/0 U1

Dual Bulb Kerf-Applied Door Bottom for Composite Adjustable, Basic Composite Adjustable, Hardwood Adjustable Sills



Non-kerf-applied option available for replacement applications. Available in bronze only.

Description	Application	Part #	Size
REPLACEMENT DOOR BOTTOM IS DP ACTIVE BRONZE	Inswing	RPDBDBU300B	3/0 U1

Inactive Door Bottoms for Composite Inswing Sills ❖

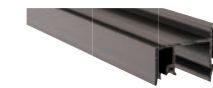

Sills:
Composite Adjustable
Hardwood Adjustable
Color:
Bronze

Description	Application	Part #	Size
TRU-DEFENSE REPLACEMENT IS INACTIVE DOOR BOTTOM BRONZE	Inswing	FDBIB14B	14"
TRU-DEFENSE REPLACEMENT IS INACTIVE DOOR BOTTOM BRONZE	Inswing	FDBIB30UB	3/0

Additional Door Bottoms Available:

Description	Application	Part #	Size
REPLACEMENT DOOR BOTTOM IS DP ACTIVE BRONZE	Inswing	RPDBDB360B	3/6

❖ TRU-DEFENSE ELIGIBLE

**DOOR SYSTEMS BUILT WITH PUBLIC ACCESS SILLS HAVE LITTLE RESISTANCE TO WATER PENETRATION AND HAVE A POTENTIAL TO LEAK IF INSTALLED EXPOSED TO WEATHER. WE RECOMMEND THESE SYSTEMS BE INSTALLED AWAY FROM WEATHER UNDER LARGE SOFFITS OR OVERHANGS.

THERMA TRU[®]
DOORS



Boise Cascade[®]
MILLWORK

millwork.bc.com
11011 E 104th Ave, Suite 1000
Commerce City, CO 80640
720-653-3333
DenverMillwork@bc.com



ASTRAGALS

Cover the margin between double doors to help complete the seal against air and moisture infiltration with aluminum construction for stability, holding power and durability. Available in a stainable wood-grained vinyl wrap or aluminum.

Aluminum Astragal

Coastal option also available.



Heights:
6'6"
6'8"
7'0"
8'0"
Width:
7/8"

Configurations:
Inswing
Outswing
Multi-Point Lock
Double Bore
Left-Handed
Right-Handed

Grain Options:
Bronze
White
Weatherstrip:
Bronze

Description	Application	Part #	Size
ASTRAGAL ALUMINUM IS STANDARD WHITE LH	Inswing	ASIS0SAAL	8/0
ASTRAGAL ALUMINUM IS STANDARD WHITE LH	Inswing	ASIS7SAAL	6/8
ASTRAGAL ALUMINUM IS STANDARD WHITE LH	Inswing	ASISPSAAL	8/0
ASTRAGAL ALUMINUM IS STANDARD WHITE RH	Inswing	ASIS0SAAR	6/6
ASTRAGAL ALUMINUM IS STANDARD WHITE RH	Inswing	ASIS7SAAR	6/8
ASTRAGAL ALUMINUM IS STANDARD WHITE RH	Inswing	ASISPSAAR	8/0
ASTRAGAL ALUMINUM OS STANDARD WHITE LH	Outswing	ASOS7SAAL	6/8
ASTRAGAL ALUMINUM OS STANDARD WHITE LH	Outswing	ASOSPSAAL	8/0
ASTRAGAL ALUMINUM OS STANDARD WHITE RH	Outswing	ASOS7SAAR	6/8
ASTRAGAL ALUMINUM OS STANDARD WHITE RH	Outswing	ASOSPSAAR	8/0

END RAIL

Description	Part #	Size
CC REPLACEMENT KERF END RAIL	RPCCER30C	3/0
CC REPLACEMENT KERF END RAIL	RPCCER36SS	3/6
REPLACEMENT END RAIL	RPER36C	3/6
REPLACEMENT KERF ENDRAIL STEEL	RPER30C	3/0
SS REPLACEMENT KERF END RAIL	RPSSFCER30C	3/0

WEATHERSTRIP

Engineered in a variety of profiles for a precise seal between the door and frame. Made of a flexible protected by a durable jacket to resist moisture and wear.

Medium-Reach Weatherstrip



Colors:
Bronze
White

Long-Reach Weatherstrip



Colors:
Bronze
White

Description	Part #	Size	Color
WEATHERSTRIP HEAD LONG REACH 37"	WHFB	3/0	Bronze
WEATHERSTRIP HEAD MEDIUM REACH 38"	WHFB7	3/0	Bronze
WEATHERSTRIP SIDE LONG REACH 81"	WSFB	6/8	Bronze
WEATHERSTRIP SIDE LONG REACH	WS8FB	8/0	Bronze
WEATHERSTRIP SIDE MEDIUM REACH 81"	WSFB7	6/8	Bronze
WEATHERSTRIP SIDE MEDIUM REACH 97"	WS8FB7	8/0	Bronze
WEATHERSTRIP SIDE SHORT REACH	WS8FB6	8/0	Bronze





EXTERIOR HINGES

Hinges position the door to properly compress the weatherstrip and help ensure smooth operation. Features options to suit various applications and mate with mortise pockets machined into our doors.

Classic Craft
Ball-Bearing Staggered
Hole Pattern Hinge



Description	Finish	Part #	Size
CC NRP HINGE BALL BEARING STAGGERED	Brushed Nickel	HGBCCSR5NRP-1C	5/8"
CC NRP HINGE BALL BEARING STAGGERED	Black Nickel	HGBCCSR5NRP-1D	5/8"
CC NRP HINGE BALL BEARING STAGGERED	Rubbed Bronze	HGBCCSR5NRP-1H	5/8"
CC NRP HINGE BALL BEARING STAGGERED	Yellow Zinc	HGBCCSR5NRP-YZ	5/8"
CC HINGE BALL BEARING STAGGERED	Brushed Nickel	HGBCCR5S-1C	5/8"
CC HINGE BALL BEARING STAGGERED	Black Nickel	HGBCCR5S-1D	5/8"
CC HINGE BALL BEARING STAGGERED	Rubbed Bronze	HGBCCR5S-1H	5/8"
CC HINGE BALL BEARING STAGGERED	Yellow Zinc	HGBCCR5S-YZ	5/8"

Self-Aligning
Ball-Bearing Hinge



Description	Finish	Part #	Size
HINGE BALL BEARING RH	Black Nickel	HGBBR5-1D	5/8"
HINGE BALL BEARING RH	Brushed Nickel	HGBBR5-1C	5/8"
HINGE BALL BEARING RH	Oil-Rubbed Bronze	HGBBR5-1H	5/8"
HINGE BALL BEARING RH	Yellow Zinc	HGBBR5-YZ	5/8"
HINGE BALL BEARING LH	Black Nickel	HGBBL5-1D	5/8"
HINGE BALL BEARING LH	Brushed Nickel	HGBBL5-1C	5/8"
HINGE BALL BEARING LH	Oil-Rubbed Bronze	HGBBL5-1H	5/8"
HINGE BALL BEARING LH	Yellow Zinc	HGBBL5-YZ	5/8"

Self-Aligning
Hinge

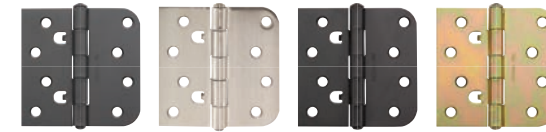

Description	Finish	Part #	Size
HINGE NRP BULK PACK	Black Nickel	HG58RP-1D-S	5/8"
HINGE NRP BULK PACK	Brushed Nickel	HG58RP-1C-S	5/8"
HINGE NRP BULK PACK	Oil-Rubbed Bronze	HG58RP-1H-S	5/8"
HINGE NRP BULK PACK	Yellow Zinc	HG58RPYZ-S	5/8"
HINGE BULK PACK	Brushed Nickel	HG58-1C-S	5/8"
HINGE SELF ALIGNING BULK PACK	Oil-Rubbed Bronze	HG58-1H-S	5/8"
HINGE ASSEMBLED LH	Yellow Zinc	HG58YZLA	5/8"
HINGE ASSEMBLED RH	Yellow Zinc	HG58YZRA	5/8"

Spring-Loaded
Hinge

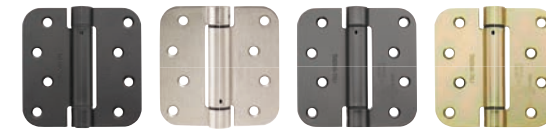

Description	Finish	Part #	Size
HINGE SPRING LOADED	Black Nickel	HG58SL-1D	5/8"
HINGE SPRING LOADED	Brushed Nickel	HG58SL-1C	5/8"
HINGE SPRING LOADED	Oil-Rubbed Bronze	HG58SL-1H	5/8"
HINGE SPRING LOADED	Yellow Zinc	HG58SLYZ	5/8"





INTERIOR HINGES

We can special order anything and in any color – need another color/size? Just ask!



3.5" Radius Hinge

Description	Finish	Part #	Size
US15 SATIN NICKLE RADIUS SI 3.5x3.5 5/8	Satin Nickel		5/8
US10B OIL RUBBED BRONZE RADIUS SI 3.5x3.5 5/8	Oil-Rubbed Bronze		5/8
US1D BLACK RADIUS SI 3.5x3.5 5/8	Black Nickel		5/8
US26D SATIN CHROME SI 3.5x3.5 5/8	Satin Chrome		5/8

Ball Bearing

Description	Finish	Part #	Size
US15 SATIN NICKLE BALL BEARING HINGE SI 3.5x3.5 5/8	Satin Nickel		5/8
US10B OIL RUBBED BRONZE RADIUS BALL BEARING SI 3.5x3.5 5/8	Oil-Rubbed Bronze		5/8
US1D BLACK RADIUS BALL BEARING SI 3.5x3.5 5/8	Black Nickel		5/8
US26D SATIN CHROME BALL BEARING SI 3.5x3.5 5/8	Satin Chrome		5/8

Radius 4.0" Hinge

Description	Finish	Part #	Size
US15 SATIN NICKLE RADIUS SI 4X4 5/8	Satin Nickel		5/8"
US10B OIL RUBBED BRONZE RADIUS SI 4X4 5/8	Oil-Rubbed Bronze		5/8"
US1D BLACK RADIUS SI 4X4 5/8	Black Nickel		5/8"
US26D SATIN CHROME SI 4X4 5/8	Satin Chrome		5/8"

Ball Bearing Radius 4.0" Hinge

Description	Finish	Part #	Size
US15 SATIN NICKLE RADIUS BALL BEARING SI 4X4 5/8	Satin Nickel		5/8"
US10B OIL RUBBED BRONZE RADIUS BALL BEARING SI 4X4 5/8	Oil-Rubbed Bronze		5/8"
US1D BLACK RADIUS BALL BEARING SI 4X4 5/8	Black Nickel		5/8"
US26D SATIN CHROME BALL BEARING SI 4X4 5/8	Satin Chrome		5/8"

Self Closing Hinge

Description	Finish	Part #	Size
SELF CLOSING US15 SATIN NICKLE RADIUS SC 4X4 5/8	Satin Nickel		5/8"
SELF CLOSING US10B OIL RUBBED BRONZE RADIUS SC 4X4 5/8	Oil-Rubbed Bronze		5/8"
SELF CLOSING US1D BLACK RADIUS SC 4X4 5/8	Black Nickel		5/8"
SELF CLOSING US26D SATIN CHROME RADIUS SC 4X4 5/8	Satin Chrome		5/8"

NRP 4.0" Hinge

Description	Finish	Part #	Size
NRP US15 SATIN NICKLE RADIUS NRP 4X4 5/8	Satin Nickel		5/8"
NRP US10B OIL RUBBED BRONZE RADIUS NRP 4X4 5/8	Oil-Rubbed Bronze		5/8"
NRP US1D BLACK RADIUS NRP 4X4 5/8	Black Nickel		5/8"
NRP US26D SATIN CHROME RADIUS NRP 4X4 5/8	Satin Chrome		5/8"





HANDLESETS

Designed to complement Therma-Tru door styles from traditional to contemporary.

Available Handleset Finishes



Grip Style Handlesets

Forte



Description	Finish	Part #	Locking
HANDLESET GRIP STYLE FORTE	Black Nickel	MPGSGTHS2016-1D	Active
HANDLESET GRIP STYLE FORTE	Brushed Nickel	MPGSGTHS2016-1C	Active
HANDLESET GRIP STYLE GEAR TONGUE FORTE	Oil-Rubbed Bronze	MPGSGTHS2016-1H	Active

Prospect



Description	Finish	Part #	Locking
HANDLESET GRIP STYLE GEAR TONGUE PROSPECT	Oil-Rubbed Bronze	MPGSGTHS1986-1H	Active
HANDLESET GRIP STYLE PROSPECT	Black Nickel	MPGSGTHS1986-1D	Active
HANDLESET GRIP STYLE PROSPECT	Brushed Nickel	MPGSGTHS1986-1C	Active

Lever Style Handlesets

Heirloom



Description	Finish	Part #	Locking	Backplate
HANDLESET HEIRLOOM	Black Nickel	MPTS1123965N-1D	Active	Wide
HANDLESET HEIRLOOM	Brushed Nickel	MPTS1123965N-1C	Active	Wide
HANDLESET HEIRLOOM	Oil-Rubbed Bronze	MPTS1123965N-1H	Active	Wide

Millennium



Backplates:
Wide
Narrow
Locking:
Active
Inactive

Description	Finish	Part #	Locking	Backplate
HANDLESET MILLENNIUM	Black Nickel	MPTS151216-1D	Active	Narrow
HANDLESET MILLENNIUM	Black Nickel	MPTS1513955N-1D	Active	Wide
HANDLESET MILLENNIUM	Brushed Nickel	MPTS151216-1C	Active	Narrow
HANDLESET MILLENNIUM	Brushed Nickel	MPTS1513955N-1C	Active	Wide
HANDLESET MILLENNIUM	Oil-Rubbed Bronze	MPTS151216-1H	Active	Narrow
HANDLESET MILLENNIUM	Oil-Rubbed Bronze	MPTS1513955N-1H	Active	Wide
HANDLESET MILLENNIUM	Black Nickel	DTS151216-1D	Inactive	Narrow
HANDLESET MILLENNIUM	Black Nickel	DTS1513955N-1D	Inactive	Wide
HANDLESET MILLENNIUM	Brushed Nickel	DTS151216-1C	Inactive	Narrow
HANDLESET MILLENNIUM	Brushed Nickel	DTS1513955N-1C	Inactive	Wide
HANDLESET MILLENNIUM	Oil-Rubbed Bronze	DTS151216-1H	Inactive	Narrow
HANDLESET MILLENNIUM	Oil-Rubbed Bronze	DTS1513955N-1H	Inactive	Wide

Venture



Description	Finish	Part #	Locking	Backplate
HANDLESET VENTURE	Black Nickel	MPTS10203965N-1D	Active	Wide
HANDLESET VENTURE	Brushed Nickel	MPTS10203965N-1C	Active	Wide
HANDLESET VENTURE	Oil-Rubbed Bronze	MPTS10203965N-1H	Active	Wide





Boise Cascade[®]
MILLWORK

HARDWARE

Security Strike Plate

Adjustable security strike plate wraps around the jamb and engages the frame for added support and strength, and resistance against forced entry.

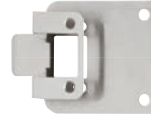

Description	Finish	Part #
TRU-DEFENSE ADJUSTABLE SECURITY STRIKE PLATE JAMB	Black Nickel	MS00SSPTD-1D
TRU-DEFENSE ADJUSTABLE SECURITY STRIKE PLATE JAMB	Brushed Nickel	MS00SSPTD-1C
TRU-DEFENSE ADJUSTABLE SECURITY STRIKE PLATE JAMB	Oil-Rubbed Bronze	MS00SSPTD-1H
TRU-DEFENSE ADJUSTABLE SECURITY STRIKE PLATE JAMB	Yellow Zinc	MS00SSPTD-1Z

DOOR & LITE DIVIDER BARS

Wood-grained or smooth SDL bars adhere to the interior and exterior panes of tempered glass and can be stained or painted to complement the door and home. 4-1/4" and 5-1/2" flat profile bars are also used on solid-panel doors as door divider bars.

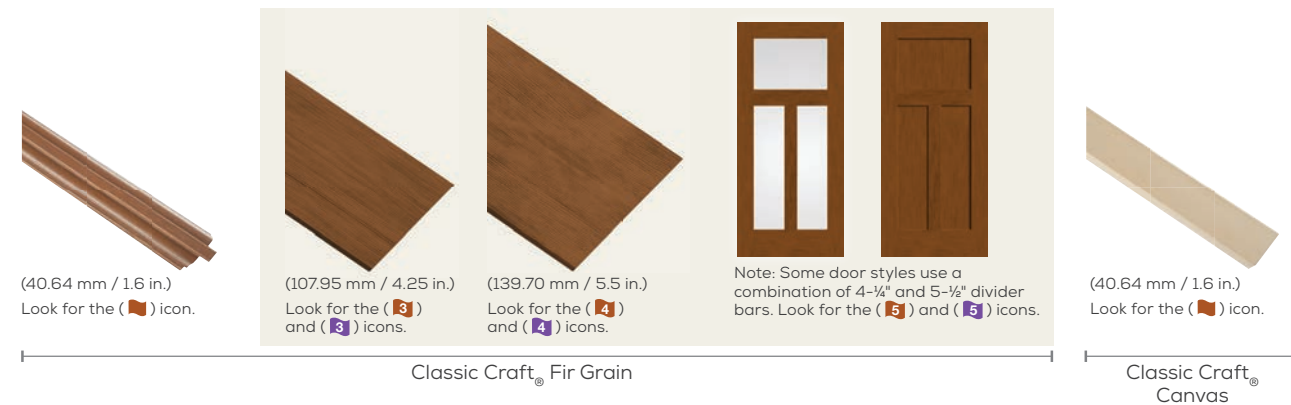

Description	Part #	Width
CCA 24 PIECE DOOR VERTICAL DIVIDER PACK For use with 3'6" Flush-Glazed Doors.	CCA36LD3024V24	1.6"
CCA 4-LITE DOOR DIVIDER KIT 1 PER PACK For use with 3'6" Flush-Glazed Doors.	CCALD3024L4-1	1.6"
CCA 6-LITE DOOR DIVIDER KIT 1 PER PACK For use with 3'6" Flush-Glazed Doors.	CCALD3024L6-1	1.6"
CCA STYLE LITE DIVIDER 4-LITE DOOR PACKAGE 1 PER PACK Contains 2 vertical and 4 horizontal pieces (1 door).	CCALD2618L4-1	1.6"
CCA STYLE LITE DIVIDER 6-LITE DOOR PACKAGE 1 PER PACK Contains 2 vertical and 6 horizontal pieces (1 door).	CCALD2618L6-1	1.6"
CCA STYLE LITE DIVIDER SIDELITE LONG HORIZONTAL 20-PACK Contains 20 long horizontal pieces.	CCALDSLHL20	1.6"
CCA STYLE LITE DIVIDER VERTICAL 24-PACK For use with 26" x 66" and 26" x 80" shaker flush-glazed doors and opaque 1 panel shaker.	CCALD2618V24	1.6"
CCS WI 5.5 DOOR/LITE DIVIDER LINEAL BULK PACK For use with 26" x 66" and 26" x 80" shaker flush-glazed doors and opaque 1 panel shaker.	CCS5LD86-6	5.5"
CCS WI DOOR/LITE DIVIDER LINEAL BULK PACK For use with 26" x 66" and 26" x 80" shaker flush-glazed doors and opaque 1 panel shaker.	CCS4LD86-6	4.25"
CCV LITE DIVIDER SIDELITE HORIZONTAL 20 PER PACK	CCVLDSLH-20	1.6"

DENTIL SHELVES

Complete the look with a dentil shelf for true Craftsman appeal or to complement other architectural elements around the house. Includes 4- and 16-block options.

Description	Part #	Size
CCA 4-BLOCK DENTIL SHELF	CCADS04	26.2"
CCA 4-BLOCK DENTIL SHELF	CCA36DS04	35.1"
CCV 4-BLOCK DENTIL SHELF	CCVDS04	25.8"



Classic Craft[®] Fir Grain 4-Block Dentil Shelf



Classic Craft[®] Canvas 4-Block Dentil Shelf



Classic Craft[®] Fir Grain 4-Block Dentil Shelf
(Pairs with 3'6" wide doors.)

Description	Part #	Size
FC DENTIL SHELF	DSB4BLK	26.2"
SS DENTIL SHELF	DSW4BLK	25.4"



Fiber-Classic[®] 4-Block Dentil Shelf*



Smooth-Star[®] 4-Block Dentil Shelf*



❖ TRU-DEFENSE ELIGIBLE

* NOT RECOMMENDED FOR USE BEHIND STORM DOORS OR TO BE PAINTED DARK COLORS, IF EXPOSED TO DIRECT SUNLIGHT.

THERMA TRU[®]
DOORS



Boise Cascade[®]
MILLWORK

millwork.bc.com
11011 E 104th Ave, Suite 1000
Commerce City, CO 80640
720-653-3333
DenverMillwork@bc.com



Boise Cascade[®]
MILLWORK

DOUGLAS FIR EXTERIOR DOORS*

All Douglas Fir exterior doors and sidelights are 1-3/4" thick, come standard with UltraBlock[®] technology and are stocked in the sizes noted.

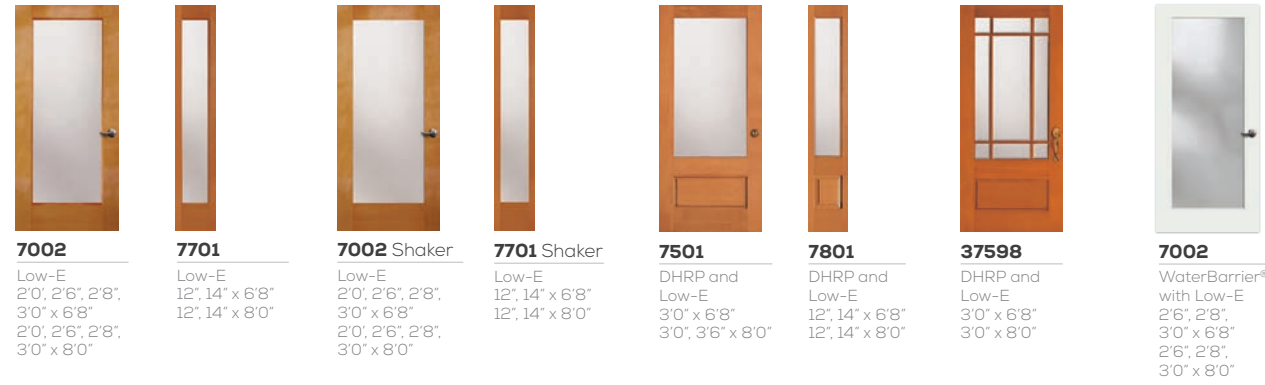

KNOTTY ALDER EXTERIOR DOORS

All Knotty Alder exterior doors and sidelights are 1-3/4" thick, come standard with UltraBlock[®] technology and are stocked in the sizes noted.

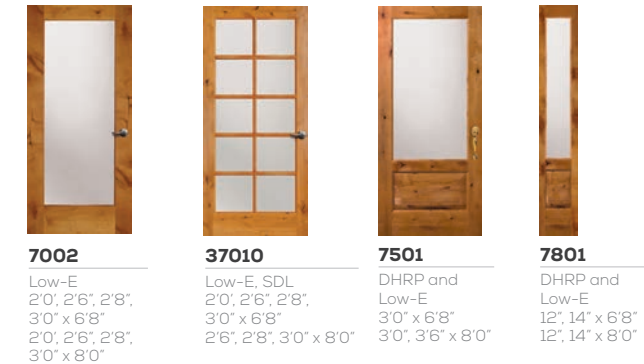

© Great NW Homes

DHRP = 1-7/16" DOUBLE HIP-RAISED PANEL
FP = 3/4" FLAT PANEL
IG = 3/4" INSULATED GLAZING
SG = 1/8" SINGLE GLAZED

* = TWO-THREE WEEK LEAD TIME

DHRP = 1-7/16" DOUBLE HIP-RAISED PANEL
IG = 3/4" INSULATED GLAZING



Boise Cascade[®]
MILLWORK

millwork.bc.com
11011 E 104th Ave, Suite 1000
Commerce City, CO 80640
720-653-3333
DenverMillwork@bc.com























Simpson[®]
Door Company

SIMPSONDOOR.COM | 800 SIMPSON | #SIMPSONDOOR



REDI-PRIME[®] INTERIOR DOORS

















All Redi-Prime[®] interior doors are 1-3/8" thick and are stocked in the sizes noted. Redi-Prime fire-rated doors are stocked 1-3/4" thick.

						
8720 Shaker 3/8" FP 1'3", 1'4", 1'6", 2'0", 2'4", 2'6", 2'8", 3'0" x 6'8" 1'4", 1'6", 2'0", 2'4", 2'6", 2'8", 3'0" x 8'0"	89320 Shaker 1-3/4" Fire-Rated 3/4" FP 2'8", 3'0" x 6'8" 2'8", 3'0" x 8'0"	8782 Shaker 3/8" FP 1'6", 2'0", 2'4", 2'6", 2'8", 3'0" x 6'8" 1'4", 1'6", 2'0", 2'4", 2'6", 2'8", 3'0" x 8'0"	89382 Shaker 1-3/4" Fire-Rated 3/4" FP 2'8", 3'0" x 6'8" 2'8", 3'0" x 8'0"	8730 Shaker 3/8" FP 1'6", 2'0", 2'4", 2'6", 2'8", 3'0" x 6'8" 1'4", 1'6", 2'0", 2'4", 2'6", 2'8", 3'0" x 8'0"	89330 Shaker 1-3/4" Fire-Rated 3/4" FP 2'8", 3'0" x 6'8" 2'8", 3'0" x 8'0"	
						
8760 Shaker 3/8" FP 1'3", 1'4", 1'6", 2'0", 2'4", 2'6", 2'8", 3'0" x 6'8" 1'6", 2'0", 2'4", 2'6", 2'8", 3'0" x 8'0"	89360 Shaker 1-3/4" Fire-Rated 3/4" FP 2'8", 3'0" x 6'8" 2'8", 3'0" x 8'0"	8755 Shaker 3/8" FP 1'4", 1'6", 2'0", 2'4", 2'6", 2'8", 3'0" x 6'8" 1'4", 1'6", 2'0", 2'4", 2'6", 2'8", 3'0" x 8'0"	89355 Shaker 1-3/4" Fire-Rated 3/4" FP 2'8", 3'0" x 6'8" 2'8", 3'0" x 8'0"	89801 Shaker† Barn Door w/ V-Groove 3'0", 3'6" x 7'0" 3'0", 3'6" x 8'4"	89812 Shaker† Barn Door w/ V-Groove 3'0", 3'6" x 7'0" 3'0", 3'6" x 8'4"	89815 Shaker† Barn Door w/ V-Groove 3'0", 3'6" x 7'0" 3'0", 3'6" x 8'4"
						
8001 Clear SG 2'0", 2'4", 2'6", 2'8", 3'0" x 6'8" 2'0", 2'4", 2'6", 2'8", 3'0" x 8'0"	8411 White Laminate 2'0", 2'4", 2'6", 2'8", 3'0" x 6'8" 2'0", 2'4", 2'6", 2'8", 3'0" x 8'0"	8010 Clear SG 2'0", 2'4", 2'6", 2'8", 3'0" x 6'8"	8012 Clear SG 2'0", 2'4", 2'6", 2'8", 3'0" x 8'0"			
						
8733 Shaker Clear SG 2'0", 2'4", 2'6", 2'8", 3'0" x 6'8"	8733 Shaker White Laminate 2'0", 2'4", 2'6", 2'8", 3'0" x 6'8"	8735 Shaker Clear SG 2'0", 2'4", 2'6", 2'8", 3'0" x 6'8" 2'0", 2'4", 2'6", 2'8", 3'0" x 8'0"	8735 Shaker White Laminate 2'0", 2'4", 2'6", 2'8", 3'0" x 6'8" 2'0", 2'4", 2'6", 2'8", 3'0" x 8'0"			

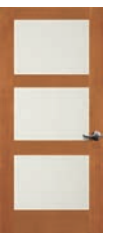
© Cynthia Brown Studio

DOUGLAS FIR INTERIOR DOORS

All Douglas Fir interior doors are 1-3/8" thick and are stocked in the sizes noted. Fire-rated doors are stocked 1-3/4" thick.

						
782 Shaker 3/8" FP 1'6", 2'0", 2'4", 2'6", 2'8", 3'0" x 6'8"	9382 Shaker 1-3/4" Fire-Rated 3/4" FP 2'8", 3'0" x 6'8"	730 Shaker 3/8" FP 1'6", 2'0", 2'4", 2'6", 2'8", 3'0" x 6'8"	9330 Shaker 1-3/4" Fire-Rated 3/4" FP 2'8", 3'0" x 6'8"	755 Shaker 3/8" FP 1'6", 2'0", 2'4", 2'6", 2'8", 3'0" x 6'8" 1'6", 2'0", 2'4", 2'6", 2'8", 3'0" x 8'0"	9355 Shaker 1-3/4" Fire-Rated 3/4" FP 2'8", 3'0" x 6'8" 2'8", 3'0" x 8'0"	
						
55† 3/4" RP 1'6", 2'0", 2'4", 2'6", 2'8", 3'0" x 6'8"	9255† 1-3/4" Fire-Rated 1-7/16" RP 2'8", 3'0" x 6'8"	1501† Clear SG 2'0", 2'4", 2'6", 2'8", 3'0" x 6'8"	1643 Shaker† Clear SG 2'0", 2'4", 2'6", 2'8", 3'0" x 6'8"	1643 Shaker† White Laminate 2'0", 2'4", 2'6", 2'8", 3'0" x 6'8"	1645 Shaker Clear SG 2'0", 2'4", 2'6", 2'8", 3'0" x 6'8"	1645 Shaker White Laminate 2'0", 2'4", 2'6", 2'8", 3'0" x 6'8"
						
66 1'6", 2'0", 2'4", 2'6", 2'8", 3'0" x 6'8"	9266 2'8", 3'0" x 6'8"					

† = TWO WEEK LEAD TIME
SG = SINGLE GLAZED
FP = FLAT PANEL
RP = RAISED PANEL

Stock status is subject to availability, please contact your Boise Cascade Millwork Representative with any questions.





Boise Cascade
MILLWORK

KNOTTY ALDER INTERIOR DOORS

All Knotty Alder interior doors are 1-3/8" thick and are stocked in the sizes noted.
Fire-rated doors are stocked 1-3/4" thick.



720 Shaker
3/8" FP
16", 2'0", 2'4", 2'6",
2'8", 3'0" x 6'8"



9320 Shaker
1-3/4" Fire-
Rated
3/4" FP
2'8", 3'0" x 6'8"



782 Shaker
3/8" FP
16", 2'0", 2'4", 2'6",
2'8", 3'0" x 6'8"



9382 Shaker
1-3/4" Fire-Rated
3/4" FP
2'8", 3'0" x 6'8"



730 Shaker
3/8" FP
16", 2'0", 2'4", 2'6",
2'8", 3'0" x 6'8"



9330 Shaker
1-3/4" Fire-Rated
3/4" FP
2'8", 3'0" x 6'8"



760 Shaker
3/8" FP
16", 2'0", 2'4", 2'6",
2'8", 3'0" x 6'8"



9360 Shaker
1-3/4" Fire-Rated
3/4" FP
2'8", 3'0" x 6'8"



755 Shaker
3/8" FP
16", 2'0", 2'4", 2'6",
2'8", 3'0" x 6'8"



9355 Shaker
1-3/4" Fire-
Rated 3/4" FP
2'8", 3'0" x 6'8"



82
3/4" RP
16", 2'0", 2'4", 2'6",
2'8", 3'0" x 6'8",
16", 2'0", 2'4", 2'6",
2'8", 3'0" x 8'0"



9282
1-3/4" Fire-Rated
1-7/16" RP
2'8", 3'0" x 6'8",
2'8", 3'0" x 8'0"



82
V-Groove 3/4" RP
16", 2'0", 2'4", 2'6",
2'8", 3'0" x 6'8",
16", 2'0", 2'4", 2'6",
2'8", 3'0" x 8'0"



9282
1-3/4" Fire-Rated
V-Groove 1-7/16" RP
2'8", 3'0" x 6'8",
2'8", 3'0" x 8'0"



7282
1-3/4"
1-7/16" RP
2'0", 2'4", 2'6", 2'8",
3'0" x 6'8",
16", 2'0", 2'4", 2'6",
2'8", 3'0", 3'6" x 8'0"



7282
1-3/4"
V-Groove 1-7/16" RP
2'0", 2'4", 2'6", 2'8",
3'0" x 6'8",
16", 2'0", 2'4", 2'6",
2'8", 3'0", 3'6" x 8'0"



465
3/4" RP
16", 2'0", 2'4", 2'6",
2'8", 3'0" x 6'8",
16", 2'0", 2'4", 2'6",
2'8", 3'0" x 8'0"



9265
1-3/4" Fire-Rated
1-7/16" RP
2'8", 3'0" x 6'8",
2'8", 3'0" x 8'0"



465
V-Groove 3/4" RP
16", 2'0", 2'4", 2'6",
2'8", 3'0" x 6'8", 16",
2'0", 2'4", 2'6", 2'8",
3'0" x 8'0"



9265
1-3/4" Fire-Rated
V-Groove 1-7/16" RP
2'8", 3'0" x 6'8",
2'8", 3'0" x 8'0"



7465
1-3/4"
1-7/16" RP
2'0", 2'4", 2'6", 2'8",
3'0" x 6'8",
16", 2'0", 2'4", 2'6",
2'8", 3'0", 3'6" x 8'0"



7465
1-3/4"
V-Groove 1-7/16" RP
2'0", 2'4", 2'6", 2'8",
3'0" x 6'8",
16", 2'0", 2'4", 2'6",
2'8", 3'0", 3'6" x 8'0"

KNOTTY ALDER INTERIOR DOORS (CONTINUED)

All Knotty Alder interior doors are 1-3/8" thick and are stocked in the sizes noted.
Fire-rated doors are stocked 1-3/4" thick.



80801 Shaker
Full Plank
Barn Door w/
V-Groove
3'0", 3'6" x 7'0",
3'0", 3'6" x 8'4"



80812 Shaker
Z Pattern
Barn Door w/
V-Groove
3'0", 3'6" x 7'0",
3'0", 3'6" x 8'4"



80815 Shaker
K Pattern
Barn Door w/
V-Groove
3'0", 3'6" x 7'0",
3'0", 3'6" x 8'4"



1501
Clear SG
2'0", 2'4", 2'6",
2'8", 3'0" x 6'8",
2'0", 2'4", 2'6",
2'8", 3'0" x 8'0"



SG = SINGLE GLAZED
FP = FLAT PANEL
RP = RAISED PANEL



Boise Cascade
MILLWORK

millwork.bc.com
11011 E 104th Ave, Suite 1000
Commerce City, CO 80640
720-653-3333
DenverMillwork@bc.com

Stock status is subject to availability, please contact your
Boise Cascade Millwork Representative with any questions.

Simpson
Door Company



SIMPSONDOOR.COM | 800 SIMPSON | #SIMPSONDOOR



Boise Cascade®
MILLWORK

PINE INTERIOR DOORS†

Southern Yellow Pine interior doors are stocked 1-3/8" with panel door designs also stocked 1-3/4" for your house-to-garage application.

								
720 Shaker 3/8" FP 16", 2'0", 2'4", 2'6", 2'8", 3'0" x 6'8"	70720 Shaker 1-3/4" House-to -Garage 3/4" FP 2'8", 3'0" x 6'8"	782 Shaker 3/8" FP 16", 2'0", 2'4", 2'6", 2'8", 3'0" x 6'8"	70782 Shaker 1-3/4" House-to -Garage 3/4" FP 2'8", 3'0" x 6'8"	760 Shaker 3/8" FP 16", 2'0", 2'4", 2'6", 2'8", 3'0" x 6'8"	70760 Shaker 1-3/4" House-to -Garage 3/4" FP 2'8", 3'0" x 6'8"	755 Shaker 3/8" FP 16", 2'0", 2'4", 2'6", 2'8", 3'0" x 6'8"	70755 Shaker 1-3/4" House-to -Garage 3/4" FP 2'8", 3'0" x 6'8"	82 3/4" RP 16", 2'0", 2'4", 2'6", 2'8", 3'0" x 6'8", 16", 2'0", 2'4", 2'6", 2'8", 3'0" x 8'0"
								
7282 1-3/4" House-to -Garage 1-7/16" RP 2'8", 3'0" x 6'8", 2'8", 3'0" x 8'0"	82 V-Groove 3/4" RP 16", 2'0", 2'4", 2'6", 2'8", 3'0" x 6'8", 16", 2'0", 2'4", 2'6", 2'8", 3'0" x 8'0"	7282 1-3/4" House-to -Garage V-Groove 1-7/16" RP 2'8", 3'0" x 6'8", 2'8", 3'0" x 8'0"	465 3/4" RP 16", 2'0", 2'4", 2'6", 2'8", 3'0" x 6'8", 16", 2'0", 2'4", 2'6", 2'8", 3'0" x 8'0"	7465 1-3/4" House-to -Garage 1-7/16" RP 2'8", 3'0" x 6'8", 16", 2'0", 2'4", 2'6", 2'8", 3'0" x 8'0"	465 V-Groove 3/4" RP 16", 2'0", 2'4", 2'6", 2'8", 3'0" x 6'8", 16", 2'0", 2'4", 2'6", 2'8", 3'0" x 8'0"	7465 1-3/4" House-to -Garage V-Groove 1-7/16" RP 2'8", 3'0" x 6'8", 2'8", 3'0" x 8'0"	44 3/4" RP 16", 2'0", 2'4", 2'6", 2'8", 3'0" x 6'8"	7344 1-3/4" House-to -Garage 1-7/16" RP 2'8", 3'0" x 6'8"
								
66 3/4" RP 16", 2'0", 2'4", 2'6", 2'8", 3'0" x 6'8", 16", 2'0", 2'4", 2'6", 2'8", 3'0" x 8'0"	7130 1-3/4" House-to -Garage 1-7/16" RP 2'8", 3'0" x 6'8", 2'8", 3'0" x 8'0"	1501 Clear SG 2'0", 2'4", 2'6", 2'8", 3'0" x 6'8", 2'0", 2'4", 2'6", 2'8", 3'0" x 8'0"	1501 Shaker Clear SG 2'0", 2'4", 2'6", 2'8", 3'0" x 6'8"	1501 White Laminate 2'0", 2'4", 2'6", 2'8", 3'0" x 6'8", 2'0", 2'4", 2'6", 2'8", 3'0" x 8'0"	1501 Shaker Quirk White Laminate 2'0", 2'4", 2'6", 2'8", 3'0" x 6'8"	1590 Pantry 2'0", 2'4", 2'6" x 6'8"		
								
1590 (8'0") Pantry with 3/4" RP 2'0", 2'4", 2'6" x 8'0"	1593 Laundry 2'8", 3'0" x 6'8"	1593 (8'0") Laundry with 3/4" RP 2'8", 3'0" x 8'0"	1310 Clear SG 2'0", 2'4", 2'6", 2'8", 3'0" x 6'8"	1312 (8'0") Clear SG 2'0", 2'4", 2'6", 2'8", 3'0" x 8'0"	1315 Clear SG 2'6", 2'8", 3'0" x 6'8"	1318 Clear SG 2'6", 2'8", 3'0" x 8'0"		

KNOTTY PINE INTERIOR DOORS†

Knotty Pine interior doors are stocked 1-3/8" with panel door designs also stocked 1-3/4" for your house-to-garage application.



							
1501 Clear SG 2'0", 2'4", 2'6", 2'8", 3'0" x 6'8", 2'0", 2'4", 2'6", 2'8", 3'0" x 8'0"	1501 White Laminate 2'0", 2'4", 2'6", 2'8", 3'0" x 6'8", 2'0", 2'4", 2'6", 2'8", 3'0" x 8'0"	1590 Pantry 2'0", 2'4", 2'6" x 6'8"					
							
82 3/4" RP 16", 2'0", 2'4", 2'6", 2'8", 3'0" x 6'8", 16", 2'0", 2'4", 2'6", 2'8", 3'0" x 8'0"	7282 1-3/4" House-to -Garage 1-7/16" RP 2'8", 3'0" x 6'8", 2'8", 3'0" x 8'0"	82 V-Groove 3/4" RP 16", 2'0", 2'4", 2'6", 2'8", 3'0" x 6'8", 16", 2'0", 2'4", 2'6", 2'8", 3'0" x 8'0"	7282 1-3/4" House-to -Garage V-Groove 1-7/16" RP 2'8", 3'0" x 6'8", 2'8", 3'0" x 8'0"	465 3/4" RP 16", 2'0", 2'4", 2'6", 2'8", 3'0" x 6'8", 16", 2'0", 2'4", 2'6", 2'8", 3'0" x 8'0"			
							
7465 1-3/4" House-to -Garage 1-7/16" RP 2'8", 3'0" x 6'8", 2'8", 3'0" x 8'0"	465 V-Groove 3/4" RP 16", 2'0", 2'4", 2'6", 2'8", 3'0" x 6'8", 16", 2'0", 2'4", 2'6", 2'8", 3'0" x 8'0"	7465 1-3/4" House-to -Garage V-Groove 1-7/16" RP 2'8", 3'0" x 6'8", 2'8", 3'0" x 8'0"	66 3/4" RP 16", 2'0", 2'4", 2'6", 2'8", 3'0" x 6'8", 16", 2'0", 2'4", 2'6", 2'8", 3'0" x 8'0"	7130 1-3/4" House-to -Garage 1-7/16" RP 2'8", 3'0" x 6'8", 2'8", 3'0" x 8'0"	80801 Shaker Full Plank Barn Door w/ V-Groove 3'0", 3'6" x 7'0", 3'0", 3'6" x 8'4"	80812 Shaker Z Pattern Barn Door w/ V-Groove 3'0", 3'6" x 7'0", 3'0", 3'6" x 8'4"	80815 Shaker K Pattern Barn Door w/ V-Groove 3'0", 3'6" x 7'0", 3'0", 3'6" x 8'4"

† = TWO WEEK LEAD TIME
SG = SINGLE GLAZED
FP = FLAT PANEL
RP = RAISED PANEL



millwork.bc.com
11011 E 104th Ave, Suite 1000
Commerce City, CO 80640
720-653-3333
DenverMillwork@bc.com





Boise Cascade
MILLWORK

MOLDED AND FLUSH INTERIOR DOORS

Special Order - S/O

In Stock - •



Molded Hollow Core 6'8" 1-3/8"

Description	1'-0"	1'-3"	1'4"	1'6"	1'8"	2'0"	2'4"	2'6"	2'8"	2'10"	3'0"
2 Panel Arch Top	S/O	S/O	S/O	•	S/O	•	•	•	•	S/O	•
2 Panel Square Top	S/O	S/O	S/O	•	S/O	•	•	•	•	S/O	•
Textured & Smooth 6 Panel	S/O	S/O	S/O	•	S/O	•	•	•	•	S/O	•
5 Panel	S/O	S/O	S/O	•	S/O	•	•	•	•	S/O	•
1 Panel Shaker	S/O	S/O	S/O	•	S/O	•	•	•	•	S/O	•
2 Panel Square Top Shaker	S/O	S/O	S/O	•	S/O	•	•	•	•	S/O	•
2 Panel Arch V-Groove	S/O	S/O	S/O	•	S/O	•	•	•	•	S/O	•

Molded Hollow Core 8'0" 1-3/8"

Description	1'-0"	1'-3"	1'4"	1'6"	1'8"	2'0"	2'4"	2'6"	2'8"	2'10"	3'0"
2 Panel Arch Top	S/O	S/O	S/O	•	S/O	•	•	•	•	S/O	•
2 Panel Square Top	S/O	S/O	S/O	•	S/O	•	•	•	•	S/O	•
Textured & Smooth 6 Panel	S/O	S/O	S/O	S/O	S/O	S/O	S/O	S/O	S/O	S/O	S/O
5 Panel	S/O	S/O	S/O	•	S/O	•	•	•	•	S/O	•
1 Panel Shaker	S/O	S/O	S/O	S/O	S/O	S/O	S/O	S/O	S/O	S/O	S/O
2 Panel Square Top Shaker	S/O	S/O	S/O	S/O	S/O	S/O	S/O	S/O	S/O	S/O	S/O
2 Panel Arch V-Groove	S/O	S/O	S/O	•	S/O	•	•	•	•	S/O	•

STICKING PROFILES

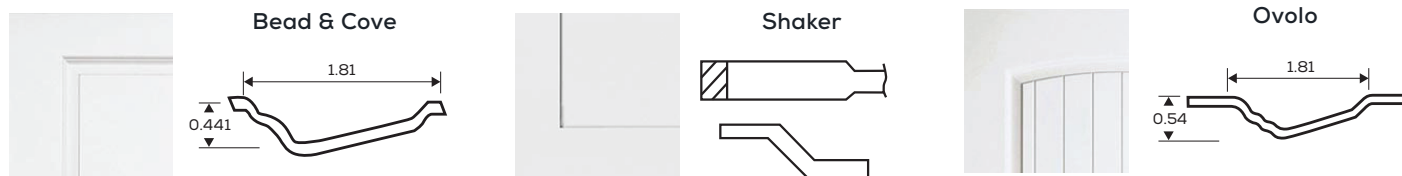

Molded Solid Core 6'8" 1-3/8"

Description	1'-0"	1'-3"	1'4"	1'6"	1'8"	2'0"	2'4"	2'6"	2'8"	2'10"	3'0"
2 Panel Arch Top	S/O	S/O	S/O	•	S/O	•	•	•	•	S/O	•
2 Panel Square Top	S/O	S/O	S/O	•	S/O	•	•	•	•	S/O	•
Textured & Smooth 6 Panel	S/O	S/O	S/O	•	S/O	•	•	•	•	S/O	•
5 Panel	S/O	S/O	S/O	•	S/O	•	•	•	•	S/O	•
1 Panel Shaker	S/O	S/O	S/O	•	S/O	•	•	•	•	S/O	•
2 Panel Square Top Shaker	S/O	S/O	S/O	•	S/O	•	•	•	•	S/O	•
2 Panel Arch V-Groove	S/O	S/O	S/O	•	S/O	•	•	•	•	S/O	•

Molded Solid Core 6'8" 1-3/4"

Description	1'-0"	1'-3"	1'4"	1'6"	1'8"	2'0"	2'4"	2'6"	2'8"	2'10"	3'0"	2'8" 20 min U1 Height	3'0" 20 min U1 Height
2 Panel Arch Top	S/O	S/O	S/O	S/O	S/O	S/O	S/O	S/O	S/O	S/O	S/O	•	•
2 Panel Square Top	S/O	S/O	S/O	S/O	S/O	S/O	S/O	S/O	S/O	S/O	S/O	•	•
Textured & Smooth 6 Panel	S/O	S/O	S/O	S/O	S/O	S/O	S/O	S/O	S/O	S/O	S/O	•	•
5 Panel	S/O	S/O	S/O	S/O	S/O	S/O	S/O	S/O	S/O	S/O	S/O	•	•
1 Panel Shaker	S/O	S/O	S/O	S/O	S/O	S/O	S/O	S/O	S/O	S/O	S/O	•	•
2 Panel Square Top Shaker	S/O	S/O	S/O	S/O	S/O	S/O	S/O	S/O	S/O	S/O	S/O	•	•
2 Panel Arch V-Groove	S/O	S/O	S/O	S/O	S/O	S/O	S/O	S/O	S/O	S/O	S/O	•	•

Molded Solid Core 8'0" 1-3/8"

Description	1'-0"	1'-3"	1'4"	1'6"	1'8"	2'0"	2'4"	2'6"	2'8"	2'10"	3'0"
2 Panel Arch Top	S/O	S/O	S/O	•	S/O	•	•	•	•	S/O	•
2 Panel Square Top	S/O	S/O	S/O	•	S/O	•	•	•	•	S/O	•
Textured & Smooth 6 Panel	S/O	S/O	S/O	S/O	S/O	S/O	S/O	S/O	S/O	S/O	S/O
5 Panel	S/O	S/O	S/O	•	S/O	•	•	•	•	S/O	•
1 Panel Shaker	S/O	S/O	S/O	S/O	S/O	S/O	S/O	S/O	S/O	S/O	S/O
2 Panel Square Top Shaker	S/O	S/O	S/O	S/O	S/O	S/O	S/O	S/O	S/O	S/O	S/O
2 Panel Arch V-Groove	S/O	S/O	S/O	•	S/O	•	•	•	•	S/O	•

Molded Solid Core 8'0" 1-3/4"

Description	1'-0"	1'-3"	1'4"	1'6"	1'8"	2'0"	2'4"	2'6"	2'8"	2'10"	3'0"	2'8" 20 min U1 Height	3'0" 20 min U1 Height
2 Panel Arch Top	S/O	S/O	S/O	S/O	S/O	S/O	S/O	S/O	S/O	S/O	S/O	•	•
2 Panel Square Top	S/O	S/O	S/O	S/O	S/O	S/O	S/O	S/O	S/O	S/O	S/O	•	•
Textured & Smooth 6 Panel	S/O	S/O	S/O	S/O	S/O	S/O	S/O	S/O	S/O	S/O	S/O	S/O	S/O
5 Panel	S/O	S/O	S/O	S/O	S/O	S/O	S/O	S/O	S/O	S/O	S/O	•	•
1 Panel Shaker	S/O	S/O	S/O	S/O	S/O	S/O	S/O	S/O	S/O	S/O	S/O	S/O	S/O
2 Panel Square Top Shaker	S/O	S/O	S/O	S/O	S/O	S/O	S/O	S/O	S/O	S/O	S/O	S/O	S/O
2 Panel Arch V-Groove	S/O	S/O	S/O	S/O	S/O	S/O	S/O	S/O	S/O	S/O	S/O	•	•



Boise Cascade
MILLWORK

millwork.bc.com
11011 E 104th Ave, Suite 1000
Commerce City, CO 80640
720-653-3333
DenverMillwork@bc.com





MOLDED AND FLUSH INTERIOR DOORS

Special Order - S/O
In Stock - •



Birch



Lauan



Primed Hardboard



Textured Primed

Flush Hollow Core 6'8"

1-3/8"

Description	1'-0"	1'-3"	1'4"	1'6"	1'8"	2'0"	2'4"	2'6"	2'8"	2'10"	3'0"
Birch	S/O	S/O	S/O	•	S/O	•	•	•	•	S/O	•
Lauan	S/O	S/O	S/O	S/O	S/O	S/O	S/O	S/O	S/O	S/O	S/O
Primed Hrdbd	S/O	S/O	S/O	•	S/O	•	•	•	•	S/O	•
Textured Primed	S/O	S/O	S/O	S/O	S/O	S/O	S/O	S/O	S/O	S/O	S/O

Flush Solid Core 6'8"

1-3/8"

Description	1'-0"	1'-3"	1'4"	1'6"	1'8"	2'0"	2'4"	2'6"	2'8"	2'10"	3'0"
Birch	S/O	S/O	S/O	•	S/O	•	•	•	•	S/O	•
Lauan	S/O	S/O	S/O	S/O	S/O	S/O	S/O	S/O	S/O	S/O	S/O
Primed Hrdbd	S/O	S/O	S/O	•	S/O	•	•	•	•	S/O	•

Flush Solid Core 8'0"

1-3/8"

Description	1'-0"	1'-3"	1'4"	1'6"	1'8"	2'0"	2'4"	2'6"	2'8"	2'10"	3'0"
Birch	S/O	S/O	S/O	S/O	S/O	S/O	S/O	S/O	S/O	S/O	S/O
Lauan	S/O	S/O	S/O	S/O	S/O	S/O	S/O	S/O	S/O	S/O	S/O
Primed Hrdbd	S/O	S/O	S/O	S/O	S/O	S/O	S/O	S/O	S/O	S/O	S/O

Flush Solid Core 6'8"

1-3/4"

20 min 20 min

Description	1'-0"	1'-3"	1'4"	1'6"	1'8"	2'0"	2'4"	2'6"	2'8"	2'10"	3'0"	2'8"	3'0"
Birch	S/O	S/O	S/O	S/O	S/O	S/O	S/O	S/O	S/O	S/O	S/O	•	•
Lauan	S/O	S/O	S/O	S/O	S/O	S/O	S/O	S/O	S/O	S/O	S/O	•	•
Primed Hrdbd	S/O	S/O	S/O	S/O	S/O	S/O	S/O	S/O	S/O	S/O	S/O	•	•

Flush Solid Core 8'0"

1-3/4"

Description	1'-0"	1'-3"	1'4"	1'6"	1'8"	2'0"	2'4"	2'6"	2'8"	2'10"	3'0"
Birch	S/O	S/O	S/O	S/O	S/O	S/O	S/O	S/O	S/O	S/O	S/O
Lauan	S/O	S/O	S/O	S/O	S/O	S/O	S/O	S/O	S/O	S/O	S/O
Primed Hrdbd	S/O	S/O	S/O	S/O	S/O	S/O	S/O	S/O	S/O	S/O	S/O





EXTERIOR FRAMES & JAMBS

Non-Stock - N/S

In Stock - •

Exterior Frames

— DURA-TECH —

Description	Primed	Knotty Alder	Douglas Fir	White Stipple	Tan Wood Grain
4-9/16" 6/8	•	•	•	•	•
4-9/16" 8/0	•	•	•	•	•
4-9/16" 2/8H	•	N/S	N/S	N/S	N/S
4-9/16" 3/0H	•	N/S	N/S	•	•
4-9/16" 6/0H	•	N/S	N/S	N/S	N/S
4-7/8" 6/8	•	•	N/S	N/S	N/S
4-7/8" 8/0	•	•	N/S	N/S	N/S
5-1/4" 6/8	•	N/S	N/S	N/S	N/S
5-1/4" 8/0	•	N/S	N/S	N/S	N/S
6-9/16" 6/8	•	•	•	•	•
6-9/16" 8/0	•	•	•	•	•
6-9/16" 2/8H	•	N/S	N/S	N/S	N/S
6-9/16" 3/0H	•	N/S	N/S	•	•
6-9/16" 6/0H	•	N/S	N/S	N/S	N/S
6-7/8" 6/8	•	•	N/S	N/S	N/S
6-7/8" 8/0	•	•	N/S	N/S	N/S
7-1/4" 6/8	•	•	N/S	•	•
7-1/4" 8/0	•	•	N/S	•	•
Mull Post 3-9/16" 6/8	•	•	•	•	•
Mull Post 3-9/16" 8/0	•	•	•	•	•
Mull Post 4-3/8" 6/8	•	•	•	•	•
Mull Post 4-3/8" 8/0	•	•	•	•	•
Mull Post 4-3/8" Wide 6/8	•	N/S	N/S	N/S	N/S
Mull Post 4-3/8" Wide 8/0	•	N/S	N/S	N/S	N/S
Radius Head 4-9/16" 5/4	N/S	N/S	N/S	N/S	N/S
Radius Head 4-9/16" 6/0	N/S	N/S	N/S	N/S	N/S
Radius Head 4-9/16" 3/0	N/S	N/S	N/S	N/S	N/S
Radius Head 4-9/16" 3/6	N/S	N/S	N/S	N/S	N/S
Radius Head 6-9/16" 5/4	N/S	N/S	N/S	N/S	N/S
Radius Head 6-9/16" 6/0	N/S	N/S	N/S	N/S	N/S
Radius Head 6-9/16" 3/0	N/S	N/S	N/S	N/S	N/S
Radius Head 6-9/16" 3/6	N/S	N/S	N/S	N/S	N/S
T-Astragal 1-3/4" W/S Kerf 6/8	N/S	•	•	N/S	N/S
T-Astragal 1-3/4" W/S Kerf 8/0	N/S	•	•	N/S	N/S
WM180 Brickmold 6/8	•	•	•	•	•
WM180 Brickmold 8/0	•	•	•	•	•
WM180 Brickmold 3/0H	•	N/S	N/S	N/S	N/S
WM180 Brickmold 2/8H	•	N/S	N/S	N/S	N/S

Interior Jambs

Description	Primed	Knotty Alder	Douglas Fir
4-9/16" 6/8	•	•	•
4-9/16" 8/0	•	•	•
4-7/8" 6/8	•	•	N/S
4-7/8" 8/0	•	•	N/S
5-1/4" 6/8	•	N/S	N/S
5-1/4" 8/0	•	N/S	N/S
6-9/16" 6/8	•	•	•
6-9/16" 8/0	•	•	•
6-7/8" 6/8	•	•	N/S
6-7/8" 8/0	•	•	N/S
7-1/4" 6/8	•	•	N/S
7-1/4" 8/0	•	•	N/S
WM887 Stop 6/8	•	•	•
WM887 Stop 8/0	•	•	•
T-astragal 1-3/8" 6/8	•	N/S	N/S
T-astragal 1-3/8" 8/0	•	•	•
T-astragal 1-3/4" 8/0	N/S	•	•



Standard Flat Jamb
with Applied Stop



Rabbit Jamb



Flat Jamb





MOULDINGS

CASING-BULLNOSE

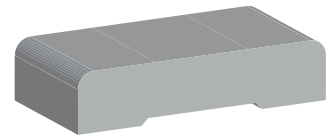

413
1 1/16" X 3-1/4" X 17'



473
9/16" X 2-1/4" X 17'

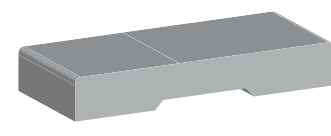

494
1/2" X 3-1/4" X 17'

BASE-BULLNOSE



433
1/2" X 3-1/4" X 16'



603
1/2" X 5" X 16'



803
1/2" X 7-1/4" X 16'

ANDERSEN



346
9/16" X 2-1/4" X 17'

COLONIAL



623
1/2" X 3-1/4" X 16'

1X BOARDS

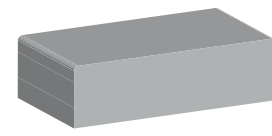

- | | |
|------------------------------|--------------------------------|
| 1X2
11/16" X 1-3/4" X 16' | 1X6
11/16" X 5-1/2" X 16' |
| 1X3
11/16" X 2-1/2" X 17' | 1X8
11/16" X 7-1/4" X 16' |
| 1X4
11/16" X 3-1/2" X 16' | 1X12
11/16" X 11-1/4" X 16' |

BARN DOOR HARDWARE

Item	Length	Description
769059001	6'	BARN DOOR BENT STRAP SET FLAT BLACK
769059003	8'	BARN DOOR BENT STRAP SET FLAT BLACK
769059005	6'	BARN DOOR BENT STRAP SET SATIN NICKEL
769059007	8'	BARN DOOR BENT STRAP SET SATIN NICKEL

KWIKSET



Item	Length	Description	
653000607		158 SQT 11P SMT RCAL 5063	158 DEADBOLT VENETIAN BRONZE
653002629		660 11P SMT RCAL RCS	660 DEADBOLT VENETIAN BRONZE
653002638		660 15 SMT RCAL RCS	660 DEADBOLT SATIN NICKEL
653003135		780 15 SMT RCAL 5063	780 DEADBOLT SATIN NICKEL
653003136		780 11P SMT RCAL 5063	780 DEADBOLT VENETIAN BRONZE
653003137		158 SQT 15 SMT RCAL 5063	158 DEADBOLT SATIN NICKEL
653003907		9260 CNT 15 SMT RBP RCALFD	SMARTCODE DEADBOLT CONTEMPORARY SATIN NICKEL 2/CASE
653003913		9260 TRL 11P SMT RBP RCALFD	SMARTCODE DEADBOLT TRADITIONAL VENETIAN BRONZE 2/CASE
653003917		9260 TRL 15 SMT RBP RCALFD	SMARTCODE DEADBOLT TRADITIONAL SATIN NICKEL 2/CASE
653040504		966BL 15 LH	BALBOA SATIN NICKEL INTERIOR HANDLE LH
653040505		966BL 15 RH	BALBOA SATIN NICKEL INTERIOR HANDLE RH
653040513		966BL 11P LH	BALBOA VENETIAN BRONZE INTERIOR HANDLE LH
653040514		966BL 11P RH	BALBOA VENETIAN BRONZE INTERIOR HANDLE RH
653041440		400CV 11P SMT 6AL RCS	COVE KNOB ENTRY VENETIAN BRONZE SMARTKEY 6-WAY ADJUSTABLE LATCH ALL PARTS LOOSE ROUND CORNER STRIKE 3 LOCKSETS KEYED ALIKE
653041493		966CV 11P	COVE KNOB INTERIOR PACK SINGLE CYLINDER VENETIAN BRONZE
653041494		966CV 15	COVE KNOB INTERIOR PACK SINGLE CYLINDER SATIN NICKEL
653041834	15 COVE ENTRY	400CV 15 SMT 6AL RCS VIEW PACK	COVE KEYED ENTRY SATIN NICKEL 94002-821
653042404		966H 15	HANCOCK INTERIOR PACK SATIN NICKEL SINGLE CYLINDER 4/CASE
653042410		966H 11P	HANCOCK INTERIOR HANDLE VENETIAN BRONZE
653042411		740H 11P SMT 6AL RCS	HANCOCK KNOB ENTRY VENETIAN BRONZE SMART KEY 6 WAY LATCH 12/CASE
653042420		740H 15 SMT 6AL RCS	HANCOCK KNOB ENTRY SATIN NICKEL SMART KEY 6 WAY LATCH 12/CASE
653060310		405BL 11P SMT 6AL RCS	BALBOA LEVER VENETIAN BRONZE
653061440		405BL 15 SMT 6AL RCS	BALBOA LEVER SATIN NICKEL
653062404		740HFL SQT 15 SMT 6AL RCS	HALIFAX LEVER KEYED ENTRY SQUARE TRIM SATIN NICKEL SMARTKEY SECURITY 6-WAY ADJUSTABLE LATCH ALL PARTS LOOSE ROUND CORNER STRIKE 97402-810
653062423		740HFL SQT 11P SMT 6AL RCS	HALIFAX LEVER KEYED ENTRY SQUARE TRIM VENETIAN BRONZE SMARTKEY SECURITY 6-WAY ADJUSTABLE LATCH ALL PARTS LOOSE ROUND CORNER STRIKE 97402-822
653062493		966HFL SQT 11P	HALIFAX LEVER INTERIOR PACK SINGLE CYLINDER SQUARE ROSE VENETIAN BRONZE 99660-124
653062494		966HFL SQT 15	HALIFAX LEVER INTERIOR PACK SINGLE CYLINDER SQUARE ROSE SATIN NICKEL 99660-121
653080005		687AMD LIP 15 SMT RCAL RCS	AMADOR HANDLESET SATIN NICKEL
653080006		687AMD LIP 11P SMT RCAL RCS	AMADOR HANDLESET VENETIAN BRONZE
653081315		687DA LIP 15 SMT RCAL RCS	DAKOTA HANDLESET SATIN NICKEL
653081316		687DA LIP 11P SMT RCAL RCS	DAKOTA HANDLESET VENETIAN BRONZE
653082100		971HFL SQT 15	HALIFAX SINGLE CYLINDER INTERIOR PACK W/SQUARE ROSETTE SATIN NICKEL
653082104		971HFL SQT 11P	HALIFAX SINGLE CYLINDER INTERIOR PACK W/SQUARE ROSETTE VENETIAN BRONZE
653082404		800HE LIP 15 SMT RCAL 5063	HAWTHORNE HANDLESET SATIN NICKEL
653082405		800HE LIP 11P SMT RCAL 5063	HAWTHORNE HANDLESET VENETIAN BRONZE
653086024		800SCE LIP 15 SMT RCAL RCS	SAN CLEMENTE HANDLESET SATIN NICKEL
653086033		7690 800SCE LIP 11P SMT RCAL RCS	SAN CLEMENTE HANDLESET VENETIAN BRONZE





Boise Cascade®
MILLWORK

DURA-TECH™

The next generation of high performance door frames.

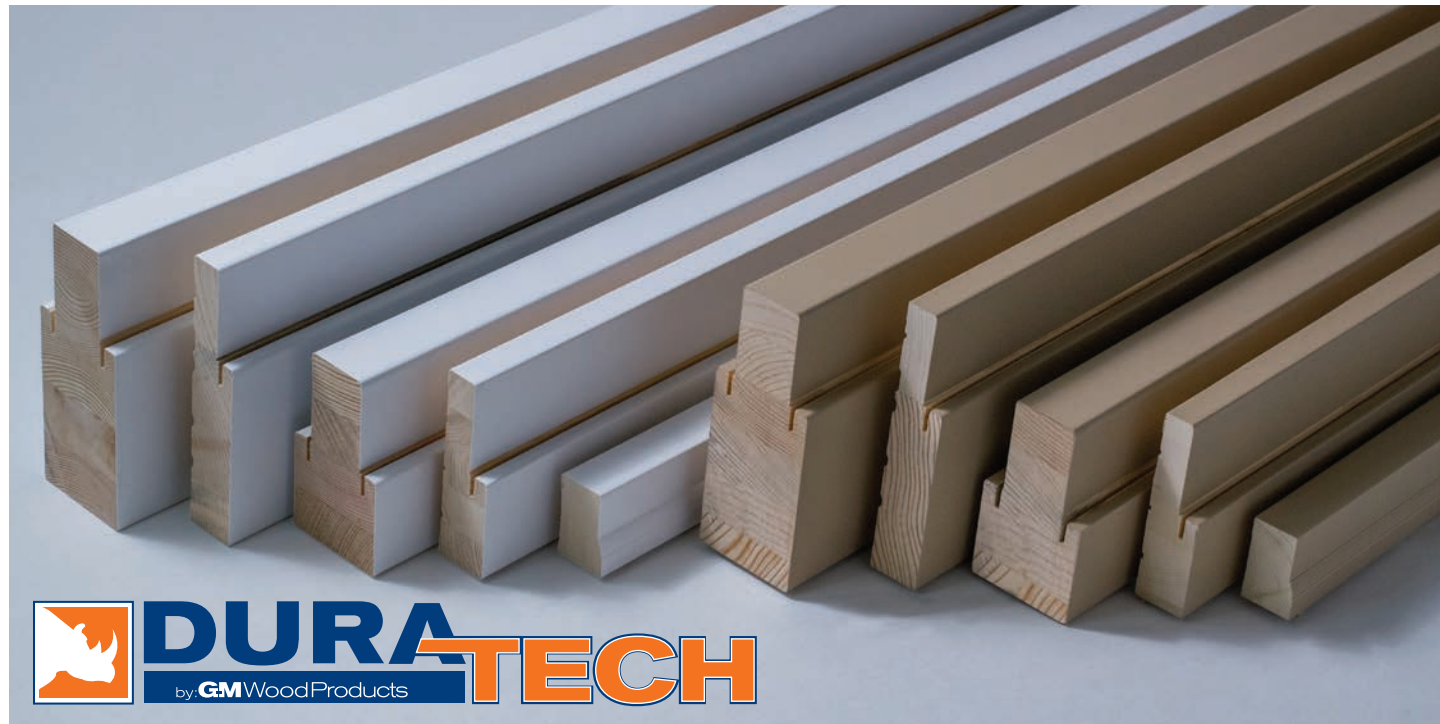

Built on the very successful rot resistant Alaskan Yellow Cypress bottomed DURA-FRAME product line, DURA-TECH raises the standard of exterior finish performance at a competitive price.

Dura-Tech™ PVC Film Technology

- DURA-TECH is a 12 mil rigid PVC film bonded with permanent waterproof exterior polyurethane glue to our lifetime rot resistant DURA-FRAME substrate system.
- DURA-FRAME™ is: Alaskan Yellow Cypress, one of the planet's most durable rot resistant woods, finger jointed to the bottom of a premium pine frame component.
- DURA-TECH offers the strength and rigidity of wood with the low maintenance attributes of PVC components.
- DURA-TECH offers versatility in your finishing options. The UV resistant, impact resistant white with a light stipple finish is a low maintenance prefinished product that can be installed as is, or painted as desired with exceptional results. DURA-TECH will make paint peeling issues a thing of the past.
- DURA-TECH is offered in a tan stainable woodgrain embossed finish for stained fiberglass applications. It is made from the same 12 mil impact resistant rigid PVC film and is designed to be stained and protected by UV resistant topcoats which require some maintenance over time.

Complete product offering

- Door Jambs
- Brick Mould
- Mull Posts
- Mull Casing

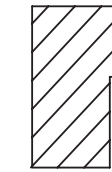

Brickmould

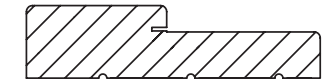

Door Jambs

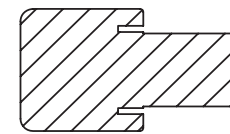

Mull Posts

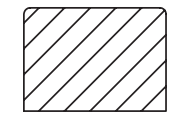

Mull Casing

Finishes

Available in PrismaGuard.



Embossed
Ready to Stain



UV Resistant White
Stipple Finish



Features & Benefits:

- **DURABLE:** Thick, rigid, impact-resistant PVC finish. Permanent waterproof adhesive.
- **STABLE:** Dura-Frame Lifetime Warranty wood substrate with Alaskan Yellow Cypress bottom.
- **TWO FINISHES:** Available in UV resistant white and embossed tan. Both are paintable and stainable.
- **PROFILES:** Available in all standard profiles. Custom profiles are available upon request.
- **Available for prefinish in PrismaGaurd.**



millwork.bc.com
11011 E 104th Ave, Suite 1000
Commerce City, CO 80640
720-653-3333
DenverMillwork@bc.com





ECLISSE POCKET DOOR FRAMES

Item	Size	Description	Extended Description
7712680**	1468	ALUM TRACK 200# BB HDWE NO JAMB LEG 2X4	1/4X6/8 BUILT UP PDF 4-5/8"
7712682	1668	ALUM TRACK 200# BB HDWE NO JAMB LEG 2X4	1/6X6/8 BUILT UP PDF 4-5/8"
7712684	2068	ALUM TRACK 200# BB HDWE NO JAMB LEG 2X4	2/0X6/8 BUILT UP PDF 4-5/8"
7712686	2468	ALUM TRACK 200# BB HDWE NO JAMB LEG 2X4	2/4X6/8 BUILT UP PDF 4-5/8"
7712688	2668	ALUM TRACK 200# BB HDWE NO JAMB LEG 2X4	2/6X6/8 BUILT UP PDF 4-5/8"
7712690	2868	ALUM TRACK 200# BB HDWE NO JAMB LEG 2X4	2/8X6/8 BUILT UP PDF 4-5/8"
7712692	3068	ALUM TRACK 200# BB HDWE NO JAMB LEG 2X4	3/0X6/8 BUILT UP PDF 4-5/8"
7712693**	4068	ALUM TRACK 200# BB HDWE NO JAMB LEG 2X4	4/0 x 6/8 BUILT UP PDF 4-5/8"
7712694**	2080	ALUM TRACK 200# BB HDWE NO JAMB LEG 2X4	2/0X8/0 BUILT UP PDF 4-5/8"
7712696**	2480	ALUM TRACK 200# BB HDWE NO JAMB LEG 2X4	2/4X8/0 BUILT UP PDF 4-5/8"
7712698**	2680	ALUM TRACK 200# BB HDWE NO JAMB LEG 2X4	2/6X8/0 BUILT UP PDF 4-5/8"
7712700**	2880	ALUM TRACK 200# BB HDWE NO JAMB LEG 2X4	2/8X8/0 BUILT UP PDF 4-5/8"
7712702**	3080	ALUM TRACK 200# BB HDWE NO JAMB LEG 2X4	3/0X8/0 BUILT UP PDF 4-5/8"
7712706**	4080	ALUM TRACK 200# BB HDWE NO JAMB LEG 2X4	4/0X8/0 BUILT UP PDF 4-5/8"
7712730**	1668	ALUM TRACK 200# BB HDWE NO JAMB LEG 2X6	1/6X6/8 BUILT UP PDF 6-5/8"
7712732**	2068	ALUM TRACK 200# BB HDWE NO JAMB LEG 2X6	2/0X6/8 BUILT UP PDF 6-5/8"
7712734**	2468	ALUM TRACK 200# BB HDWE NO JAMB LEG 2X6	2/4X6/8 BUILT UP PDF 6-5/8"
7712736**	2668	ALUM TRACK 200# BB HDWE NO JAMB LEG 2X6	2/6X6/8 BUILT UP PDF 6-5/8"
7712738**	2868	ALUM TRACK 200# BB HDWE NO JAMB LEG 2X6	2/8X6/8 BUILT UP PDF 6-5/8"
7712740**	3068	ALUM TRACK 200# BB HDWE NO JAMB LEG 2X6	3/0X6/8 BUILT UP PDF 6-5/8"
7712742**	2080	ALUM TRACK 200# BB HDWE NO JAMB LEG 2X6	2/0X8/0 BUILT UP PDF 6-5/8"
7712744**	2480	ALUM TRACK 200# BB HDWE NO JAMB LEG 2X6	2/4X8/0 BUILT UP PDF 6-5/8"
7712746**	2680	ALUM TRACK 200# BB HDWE NO JAMB LEG 2X6	2/6X8/0 BUILT UP PDF 6-5/8"
7712748**	2880	ALUM TRACK 200# BB HDWE NO JAMB LEG 2X6	2/8X8/0 BUILT UP PDF 6-5/8"
7712750**	3080	ALUM TRACK 200# BB HDWE NO JAMB LEG 2X6	3/0X8/0 BUILT UP PDF 6-5/8"
7712754**	4080	ALUM TRACK 200# BB HDWE NO JAMB LEG 2X6	4/0X8/0 BUILT UP PDF 6-5/8"

ON SITE DOOR SHOP SERVICES

Boise Cascade Millwork offers top-of-the-line exterior and interior door solutions and components. If you can imagine it, we can get it or create it.. We have state of the art equipment and dedicated millwork professionals for any and all of your millwork needs.

Our Custom Service Offerings:

- Lock Prep
- Cutouts
- SDLs
- Card Reader Prep
- Cut Down Services
- Bore Prep
- Hinge Prep
- Pet Doors
- Access Doors
- Hidden Hinge Prep
- Prefinish - Custom Paint & Stain,

